

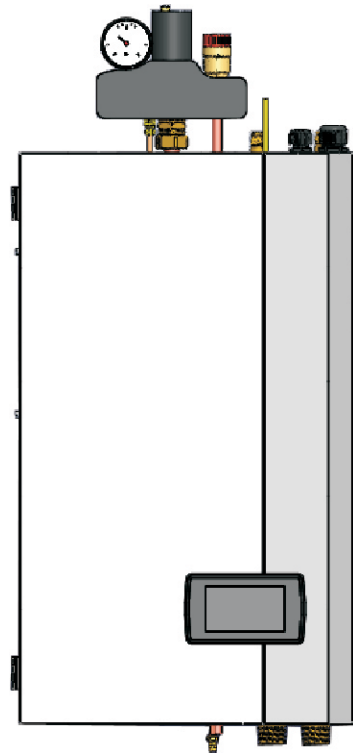

**NPH6-V7-S  
NPH9-V7-S  
NPH11-V7-S  
NPH13-V7-S**



# **DC Inverter Air to Water Heat Pump**

---

# **User's manual**

**Before operating this product, please read the instructions carefully and keep this manual for future use.**



# Catalogue

---

<b>1.Introduction</b> .....	<b>5</b>
1.1.Preliminary Information .....	5
1.2.Safety Precautions .....	6
1.3.Functioning Principles .....	8
1.4. Water Pump .....	9
1.5.Product Component Diagram .....	12
1.6.Technical Specifications .....	13
<b>2.Overview of the Units</b> .....	<b>14</b>
2.1.Functional Diagrams .....	14
2.2.Outlines and Dimensions .....	16
2.3.Exploded Views .....	19
<b>3.Assembly Configurations</b> .....	<b>22</b>
Assembly Configuration Selection Flowchart .....	22
Assembly Drawings, Wiring, and Software .....	23
<b>4.Installation Walkthrough</b> .....	<b>52</b>
4.1.Sanitary Hot Water Applications .....	52
4.2.Heating and Cooling Circuits .....	56
4.3.Indoor Unit Installation .....	59
4.4.Outdoor Unit Installation .....	61
4.5.Wiring .....	63
4.6.Refrigerant Pipework .....	73
4.7. Water Pipework .....	76
4.8.Test Run .....	77
<b>5.Appendix</b> .....	<b>78</b>
A. Wiring .....	78
B. Wiring Diagrams .....	80

# Included Accessories



Below are the accessories that are included with your purchase.  
Please check to ensure that none are missing or damaged.  
If so, please contact your local distributor.

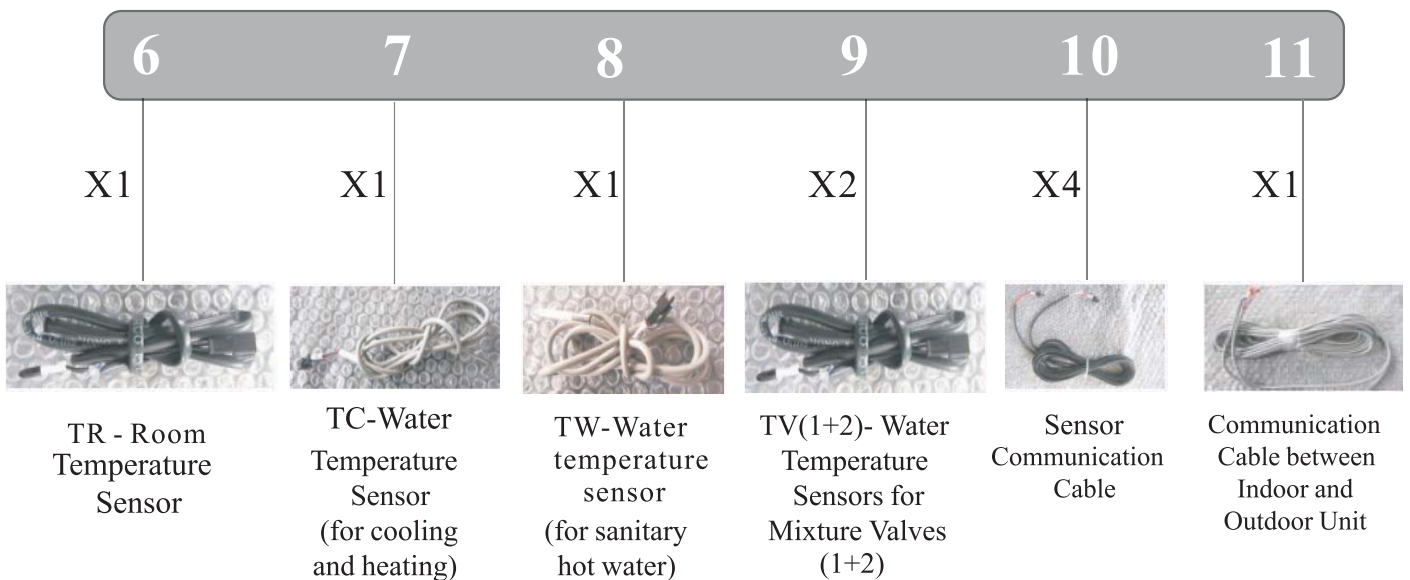
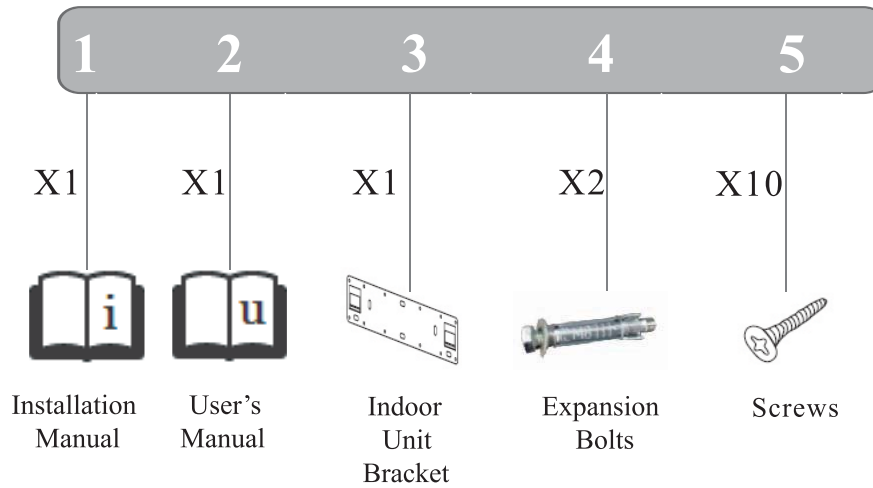

# 1. Introduction

---

## 1.1 Preliminary Information

---

Thank you for your purchase of our quality heat pump.

This manual is intended to provide detailed instructions for the successful installation of your newly purchased heat pump product. Please ensure that this manual, along with the User's and Service manuals, are kept in an easy-to-access location for your reference later on.

### DISCLAIMER

Proper adherence to the directions provided herein is vital for both the smooth operation of this system, as well as for your safety and the safety of those around you. ES Heat Pumps AB. is not responsible or liable for any losses incurred due to misuse or mishandling of this product, which includes, but is not limited to:

- Purchasing, installing, and/or operating this product with the intention of using it outside of its established, technical purpose.
- Carrying out improper work upon the unit, or any of its components, that has not been given explicit, prior consent in the form of writing.
- Installation attempts of this system by anyone other than a properly trained and licensed professional.
- Negligence of properly-worn personal protection (safety glasses, gloves, etc.) while performing installation, maintenance, or servicing of this product.
- The operation of this system during ambient temperatures which are below or beyond the temperature range intended (-25°C to 45°C)

### SAFETY

If unsure of what installation procedures to use, please contact your local distributor for information and/or advisement. Any accessories used with this product must be official only. Any electrical work must be carried out by certified electricians only. The manufacturer is not responsible for any alterations or modifications that are made without explicit, written approval. The design of this unit complies and conforms to all necessary and relevant safety regulations, and is otherwise safe to operate for its intended use.

Please pay attention to the following pages, which detail important precautions that should be closely followed, to ensure safe installation and operation .

# 1. Introduction

## 1.2. Safety Precautions

To ensure both your personal safety, as well as the safety of the product, note the symbols below and be sure to understand their correlation to each of the precautions depicted.





Warning





Caution





Prohibition

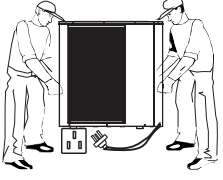

The installation, dismantlement and maintenance of the unit must be performed by qualified personnel. It is forbidden to do any changes to the structure of the unit. Otherwise injury of person or unit damage might happen.



To avoid electrical shock, make sure to disconnect the power supply 1 minute or more before servicing the electrical parts. Even after 1 minute, always measure the voltage at the terminals of main circuit capacitors or electrical parts and, before touching, make sure that those voltages are lower than the safety voltage.

Be sure to read this manual before use.

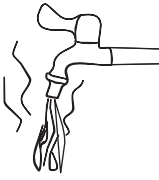

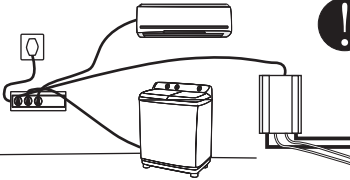

For sanitary hot water, please always add a mixture valve before water tap and set it to proper temperature.



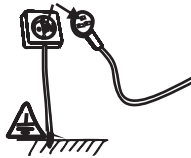

Use a dedicated socket for this unit, otherwise malfunction may occur.



Ground wire



The power supply to the unit must be grounded.

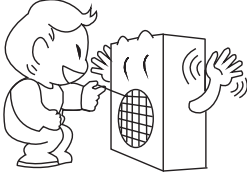

This appliance can be used by children aged from 8 years and above and persons with reduced physical, sensory or mental capabilities or lack of experience and knowledge if they have been given supervision or instruction concerning use of the appliance in a safe way and understand the hazards involved. Children shall not play with the appliance. Cleaning and user maintenance shall not be made by children without supervision.

Do not touch the air outlet grill when fan motor is running.





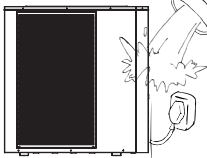

Do not touch the power plug with wet hands. Never pull out the plug by pulling the power cable.

Water or any kind of liquid is strictly forbidden to be poured into the product, or may cause electric creepage or breakdown of the product.

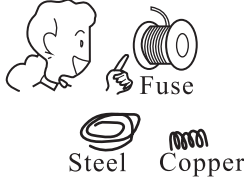
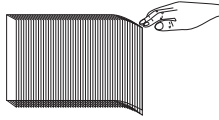
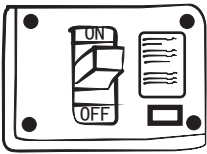
# 1. Introduction

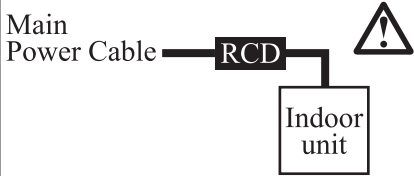
## 1.2. Safety Precautions

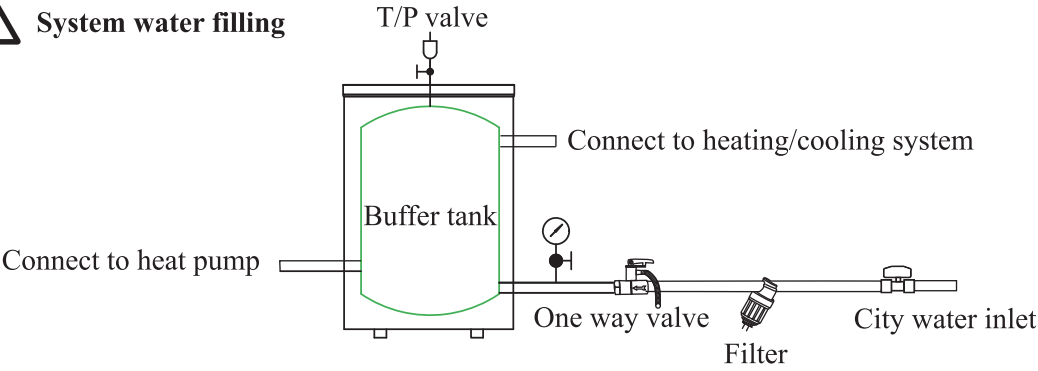
 <p>When the power cord gets loose or damaged, always get a qualified person to fix it.</p>	 <p>Please select the correct fuse or breaker as per recommended. Steel wire or copper wire cannot be taken as substitute for fuse or breaker. Otherwise, damages maybe caused.</p>	 <p>Be aware fingers might be hurt by the fin of the coil.</p>
 <p>It is mandatory to use a suitable circuit breaker for the heat pump and make sure the power supply to the unit corresponds to the specifications. Otherwise the unit might be damaged.</p>	 <p>Disposal of Scrap Batteries (if there is). Please discard the batteries as sorted municipal waste at the accessible collection point.</p>	 <p>Installation of a residual current device (RCD) having a rated residual operating current not exceeding 30 mA is advisable.</p>
<p> <b>System water filling</b></p> 		
<p>1. It's suggested to use pure water for filling the system.          2. If use city water for filling, please soften the water and add a filter.          Note: After filling, the system of water system should be 0.15~0.6MPa.</p>		
<p> </p> <p>This marking indicates that this product should not be disposed with other household wastes throughout the EU. To prevent possible harm to the environment or human health from uncontrolled waste disposal, recycle it responsibly to promote the sustainable reuse of material resources. To return your used device, please use the return and collection systems or contact the retailer where the product was purchased. They can take this product for environmental safe recycling.</p>		

# 1. Introduction

## 1.3. Functioning Principles

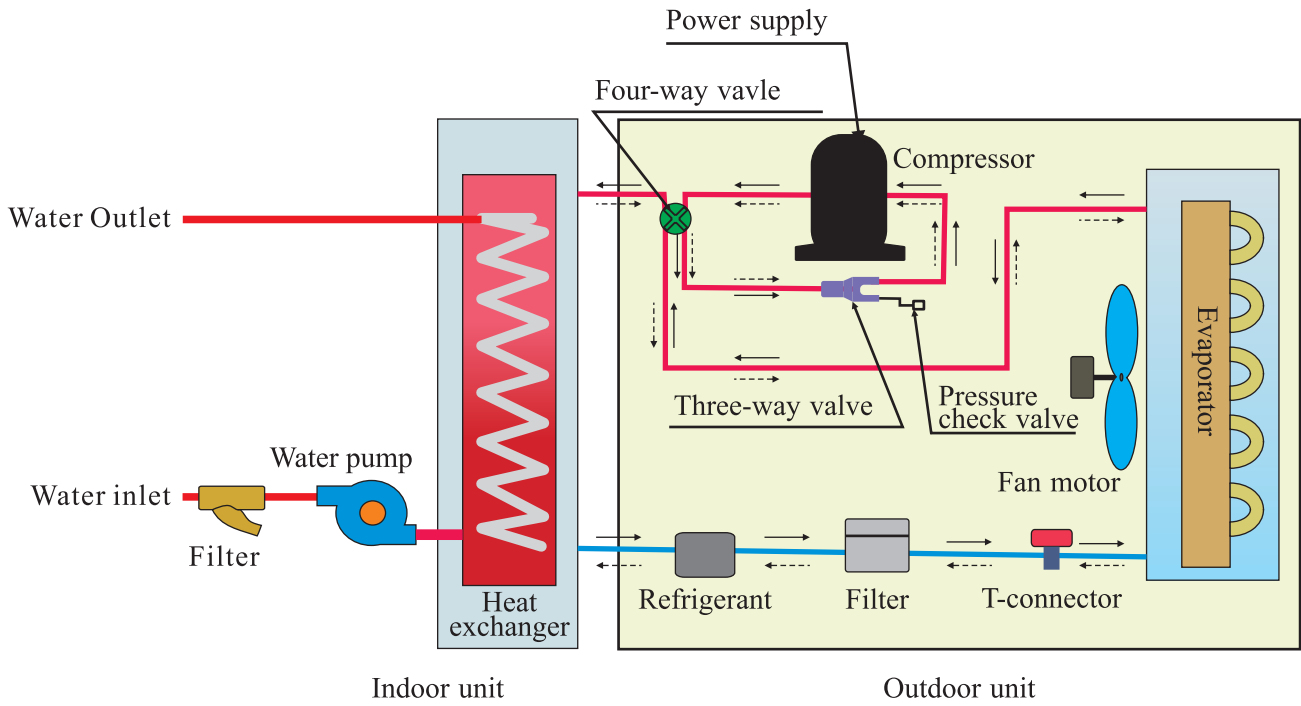



# 1. Introduction

## 1.4. Water Pump

### Setting the pump speed

The pump speed can be selected on the pump. The default setting is highest speed. If the water flow in the system is too high (e.g. noise of running water in the installation) the speed can be lowered.

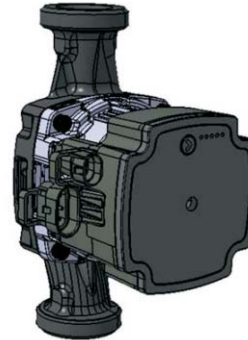
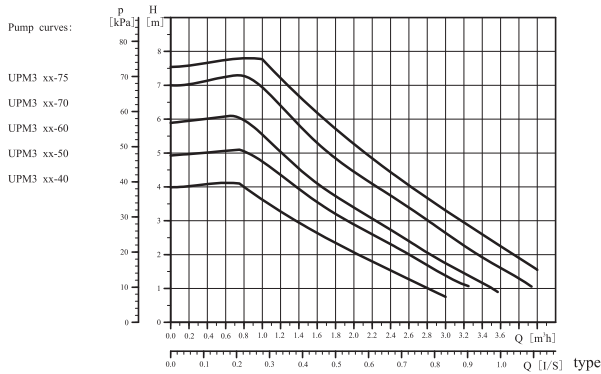

### User interface

The user interface is designed with a single push button, one red/green LED and four yellow LEDs.

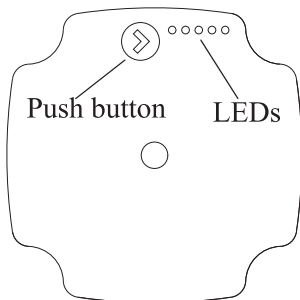

User interface with one push button and five LEDs

The user interface shows:

- performance view (during operation)
  - operation status
  - alarm status
- settings view (after pressing the button).

During operation, the display shows the performance view. If you press the button, the user interface switches the view or runs in the setting selection mode.

The user interface shows:

- performance view (during operation)
  - operation status
  - alarm status
- settings view (after pressing the button).

During operation, the display shows the performance view. If you press the button, the user interface switches the view or runs in the setting selection mode.

### Performance view

The performance view shows either the operation status or the alarm status.

### Operation area

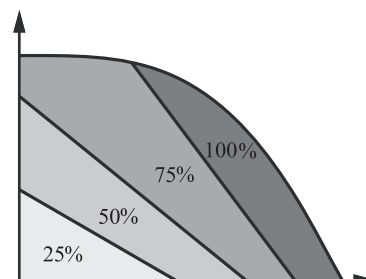

Fig. 1 Operation area according to performance load

# 1. Introduction

## 1.4. Water Pump

### Operation status

When the circulator is running, LED 1 is green. The four yellow LEDs indicate the current power consumption (P1) as shown in the table below. See fig. 1. When the operation mode is active, all active LEDs are constantly on in order to differentiate this mode from the select setting mode. If the circulator is stopped by an external signal, LED 1 flashes green.

Display	Indication	Performance in % of P1 MAX
One green LED (flashing)	Standby (only externally controlled)	0
One green LED + one yellow LED	Low performance	0-25
One green LED + two yellow LED	Medium low performance	25-50
One green LED + three yellow LED	Medium high performance	50-75
One green LED + four yellow LED	High performance	75-100

### Navigation

#### Key lock function

The purpose of the key lock function is to avoid accidental change of settings and misuse.

When the key lock function is enabled, all long key presses will be ignored. This prevents the user from entering the "select setting mode" area and allows the user to see the "show setting mode" area.

If you press the key lock for more than 10 seconds, you can toggle between enabling/disabling the key lock function. When doing so, all LEDs, except for the red LED, will flash for a second indicating that lock is toggled.



### Alarm status

If the circulator has detected one or more alarms, the bi-colored LED 1 switches from green to red. When an alarm is active, the LEDs indicate the alarm type as defined in the table below. If multiple alarms are active at the same time, the LEDs only show the error with the highest priority. The priority is defined by the sequence of the table.

When there is no active alarm anymore, the user interface switches back to operation mode.

Display	Indication	Pump operation	Counter action
One red LED + one yellow LED (LED 5)	Rotor is blocked.	Trying to start again every 1.33 seconds.	Wait or block the shaft.
One red LED + one yellow LED (LED 4)	Supply voltage too low.	Only warning, pump runs.	Control the supply voltage.
One red LED + one yellow LED (LED 3)	Electrical error.	Pump is stopped because of low supply voltage or serious failure.	Control the supply voltage / Exchange the pump.

### User interface control modes for UPM3 HYBRID variants

You can manage all UPM3 HYBRID variants with a single push button and a LED interface.

You can select the following operation modes with the push button.

The user interface shows the flashing LEDs in the combination which is described in the tables below.

#### UPM3 FLEX AS

This circulator is for either external PWM profile A signal control or speed selection.

You can define the maximum curve of the pump operation range. With PWM signal, the circulator runs at the corresponding speed. Without PWM signal, the circulator runs at maximum speed.

#### PWM profile A (heating)

UPM3 xx-70 [m]	LED1 red	LED2 yellow	LED3 yellow	LED4 yellow	LED5 yellow
4	•	•			
5	•	•		•	
6	•	•		•	•
7*	•	•			•

\* The circulator is factory-set to start in this control mode.

# 1. Introduction

---

## 1.4. Water Pump

---

### Factory presetting

The circulator starts at the factory preset.

- For standard UPM3 HYBRID, UPM3 AUTO, UPM3

AUTO L this is proportional pressure, curve 3

- For UPM3 FLEX AC and UPM3 FLEX AS this is PWM profile A, curve 4.

In the "select setting" mode the circulator starts at this control mode. The preset mode is marked with this symbol \* in the tables below.

### Setting selection

You can choose between the performance view and settings view.

If you press the button for 2 to 10 seconds, the user interface switches to "setting selection" if the user interface is unlocked. You can change the settings as they appear. The settings appear in a particular order in a closed loop. When you release the button, the user interface switches back to the performance view and the last setting is stored.

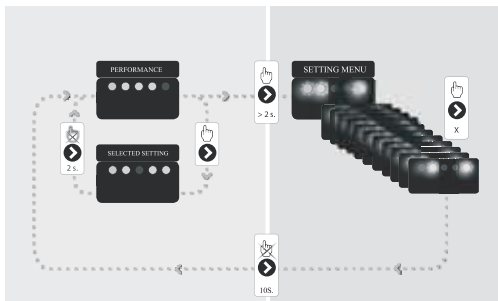

Setting selection

# 1. Introduction

## 1.5. Product Components Diagram

Below is a general system application of the heat pump. Any specific configurations should be a variation of this “master” system drawing. All suggested assembly variations are given in Chapter 3.

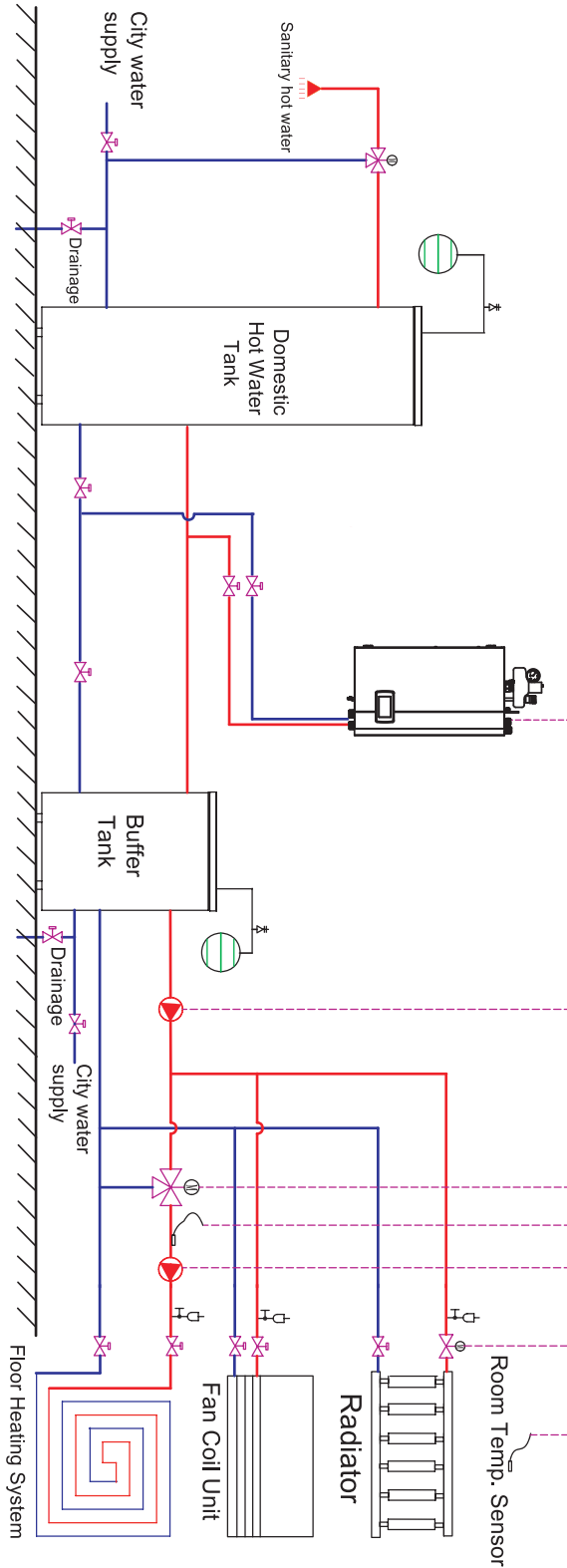

Name	Symbol	Name	Symbol
Temp. Sensor		Water pump	
Safety valve Kit		Mixing valve	
Ball valve		Motorized valve	
Water filter		Expansion tank	
Air purging valve			

Note: Dotted lines mean “able to be controlled by the Heat Pump”.

# 1. Introduction

## 1.6. Technical Specifications

MODEL		NPH6-V7-S	NPH9/11-V7-S		NPH13-V7-S
ES code	Indoor	120270	120274	120274	120279
ES code	Outdoor	120273	120277	120278	120282
ErP Energy efficiency class		A+++	A++		A++
SCOP 35°C (floor heating) EN 14825	W/W	4.47	3.99	3.92	4.08
Pdesign for SCOP EN 14825	kW	5.26	6.4	8.26	7.46
Heating/Heating mode (A7/W35)*					
Heating capacity*	kW	2.19-6.21	4.33-10.10	4.67-11.5	4.2-12.6
COP - Coefficient of Performance*	W/W	4.05-5.87	4.02-4.65	3.83-5.05	3.89-4.77
Rated input power*	kW	0.54-1.53	0.975-2.15	0.92-3.03	0.926-3.07
Heating/Heating mode (A7/W45)					
Heating capacity	kW	2.05-5.80	4.19-9.53	4.14-10.7	3.76-11.5
COP - Coefficient of Performance	W/W	3.22-4.12	3.12-3.55	2.95-3.56	2.97-3.28
Rated input power	kW	0.64-1.81	1.23-2.99	1.22-3.62	1.27-3.72
Max. temperature of heating water	°C	55	55		55
Operating range of heat pump - Heating (Ambient temperature)	°C	-25 to +45	-25 to +45		-25 to +45
Cooling mode (A35/W7)**					
Cooling capacity**	kW	1.59-4.5	2.34-5.05	2.17-6.74	2.34-7.91
Rated input power**	kW	0.61-1.74	1.08-3.20	0.92-3.13	1.0-3.01
EER - Energy Efficiency Ratio**	W/W	2.52-4.32	1.58-2.40	2.15-3.0	2.33-3.12
Min. temperature of cooling water	°C	7	7		7
Operating range of heat pump - Cooling (Ambient temperature)	°C	0 to +65	0 to +65		0 to +65
Power supply - specifications					
Voltage	V/Hz/Ph	230V/1PH/50Hz	230V/1PH/50Hz		230V/1PH/50Hz
Fuse for heat pump alone (with 230V/1PH/50Hz connection)	A/type	10A/C(230V)	16A/C(230V)		16A/C(230V)
Fuse for heat pump + electric back up	A/type	NA	NA		NA
Fuse for DHW tank electrical heater (HWTBH)	A/type	NA	NA		NA
Refrigerant specification					
Type of refrigerant	/	R410A	R410A		R410A
Refrigerant - mass	kg	1.3	2.5	2.55	3
GWP (global warming potential)	GWP	2088	2088		2088
Quantity of hydrofluorocarbons in tonnes of CO <sub>2</sub> equivalent	t CO <sub>2</sub> Equiv.	2.714	5.220	5.324	6.264
Max pressure high side	kPa	42.000	42.000		42.000
Type of compressor	/	DC inverter (twin rotary)	DC inverter (twin rotary)		DC inverter (twin rotary)
Hermetically sealed equipment (indoor/outdoor unit)		Yes	Yes		Yes
Type to connection between outdoor-indoor unit	Refrigerant / Water	Refrigerant connection	Refrigerant connection		Refrigerant connection
Dimensions of refrigerant pipes connectors	Liquid - Gas	1/4"-1/2"	3/8"-1/2"		3/8"-5/8"
Factory pre-load for pipe distance	m	5	5		12
Max. Refrigerant pipe distance	m	15	20		20
Refrigerant charge for each additional meter	g/m	40	40		40
Height difference between outdoor and indoor unit					
***Outdoor unit is above Indoor unit	m	7	7		7
****Outdoor unit is below Indoor unit	m	5	5		5
Fan					
Fan type	/	1 x Axial	1 x Axial		2 x Axial
Air flow	m <sup>3</sup> /h	2700	3000	3100	4200
Rated power	W	60	60		2x60
ΔESP <sup>†</sup> - External Static Pressure of the Fan (data per piece)	Pa	45	45		50
Water side heat exchanger					
Type	/	SWEP	SWEP		SWEP
Pressure drop	kPa	30	40		40
Dimensions of water piping connection	Inch	G1"	G1"		G1"
Allowable flow - secondary (water) side					
Min. water flow	l/s / m <sup>3</sup> /h	0.19 l/s or 0.68 m <sup>3</sup> /h	0.23 l/s or 0.86 m <sup>3</sup> /h	0.31 l/s or 1.11 m <sup>3</sup> /h	0.37 l/s or 1.32 m <sup>3</sup> /h
Nominal water flow	m <sup>3</sup> /h	1.04	1.44		2.2
Max. water flow	m <sup>3</sup> /h	1.18	2.16		2.63
Circulation water pump - A energy class	Producer and type	UPM3K FLEX AS 25-75 180 AZA	UPM3K FLEX AS 25-75 180 AZA		UPM3K FLEX AS 25-75 180 AZA
Sound power level according to EN12102					
Sound power level LwA - Indoor unit	dB(A)	47.2	43	45	46
Sound power level LwA - Outdoor unit	dB(A)	57.3	58	58	59
Sound pressure level on distance:					
Indoor unit -1 m	dB(A)	42.2	32	37	38
Outdoor unit -1 m	dB(A)	49.3	49.9	49.9	51
Outdoor unit -2 m	dB(A)	43.3	43.9	43.9	45
Outdoor unit -4 m	dB(A)	37.3	37.8	37.8	39
Outdoor unit -5 m	dB(A)	35.4	35.9	35.9	37.1
Outdoor unit -8 m	dB(A)	31.3	31.8	31.8	33
Outdoor unit -10 m	dB(A)	29.4	29.9	29.9	31.1
Outdoor unit -15 m	dB(A)	25.8	26.3	26.3	27.5
Net dimensions					
Indoor unit (WxHxD)	mm	410x750x270	410x750x270		410x750x270
Outdoor unit (WxHxD)	mm	920x353x730	947x355x755	1056x414x765	1154x460x1195
Packing dimensions					
Indoor unit (WxHxD)	mm	476x836x325	476x836x325		476x836x325
Outdoor unit (WxHxD)	mm	1010x440x880	1010x440x810	1140x490x810	1260x490x1355
Net weight					
Indoor unit	kg	29.5	31		31
Outdoor unit	kg	52.6	67.5	70	118
Packing weight					
Indoor unit	kg	31.6	32.8		32.8
Outdoor unit	kg	63	77.5	80	128

(\* ) Measured according to standard EN 14511. Heating condition: water inlet/outlet temperature 30°C/35°C. ambient temperature DB/WB7/6°C ;

(\*\* ) Measured according to standard EN 14511. Cooling condition: water inlet/outlet temperature 12°C/7°C and ambient temperature 35°C.

## 2. Overview of the Units

### 2.1. Functional Diagrams

#### Indoor unit

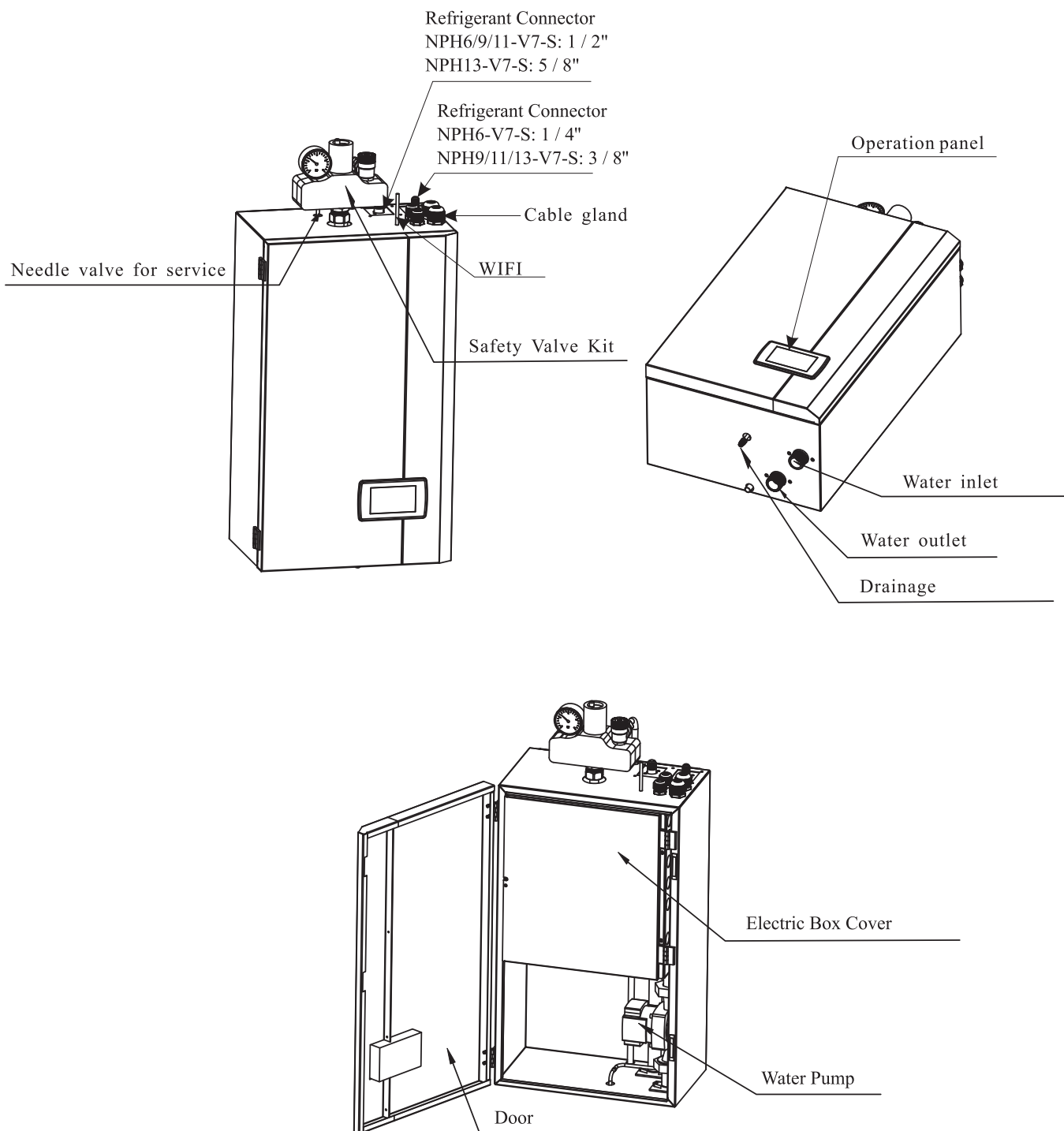

# 2. Overview of the Units

## 2.1. Functional Diagrams

### Outdoor unit

NP6-V7-S

NP9-V7-S

NP11-V7-S

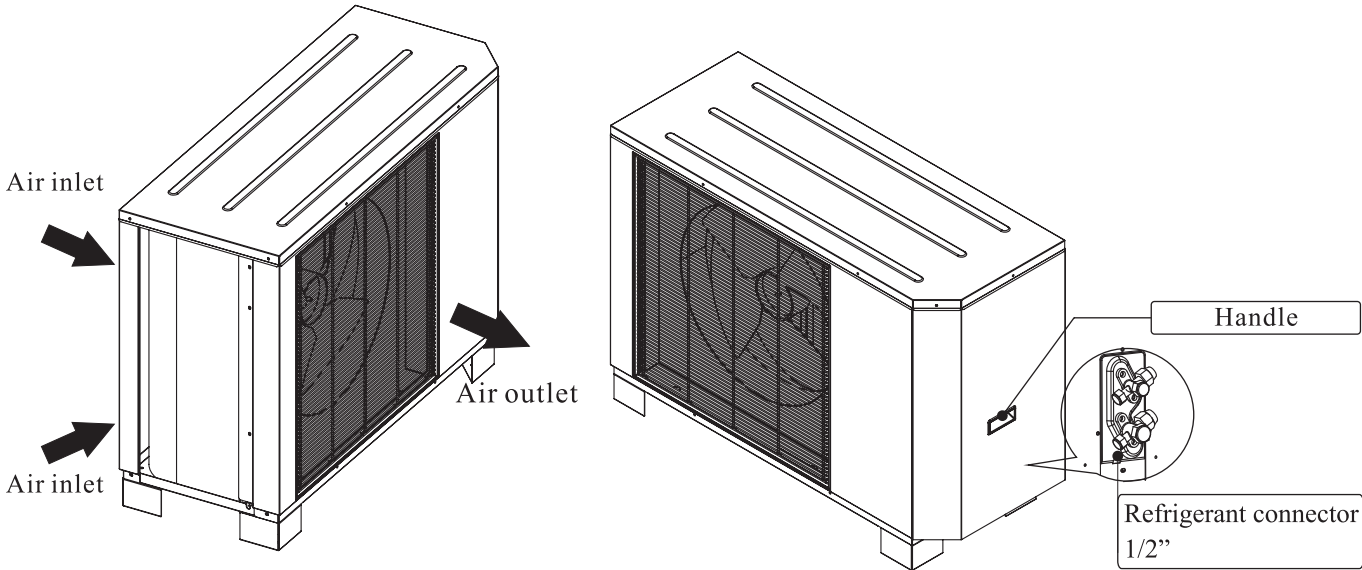

NP13-V7-S

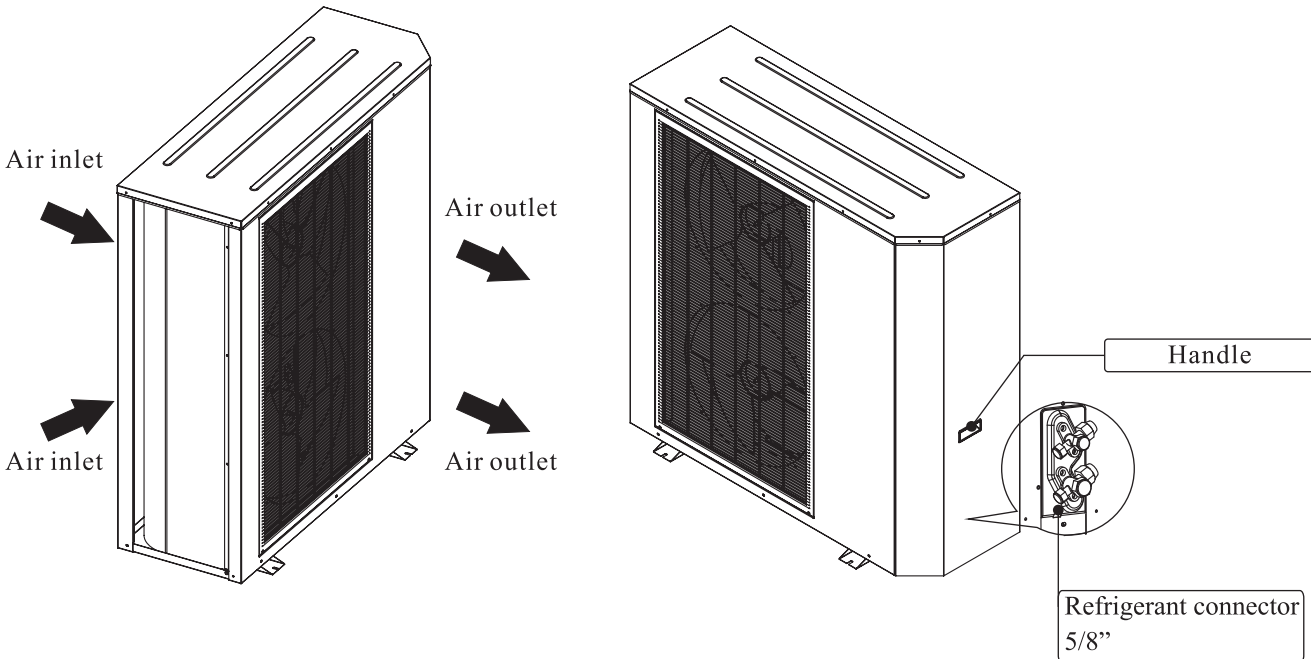

## 2. Overview of the Units

### 2.2.Outlines and Dimensions

#### Outlines and dimensions

Indoor — NPH6-V7-S  
NPH9-V7-S  
NPH11-V7-S  
NPH13-V7-S

Unit:mm

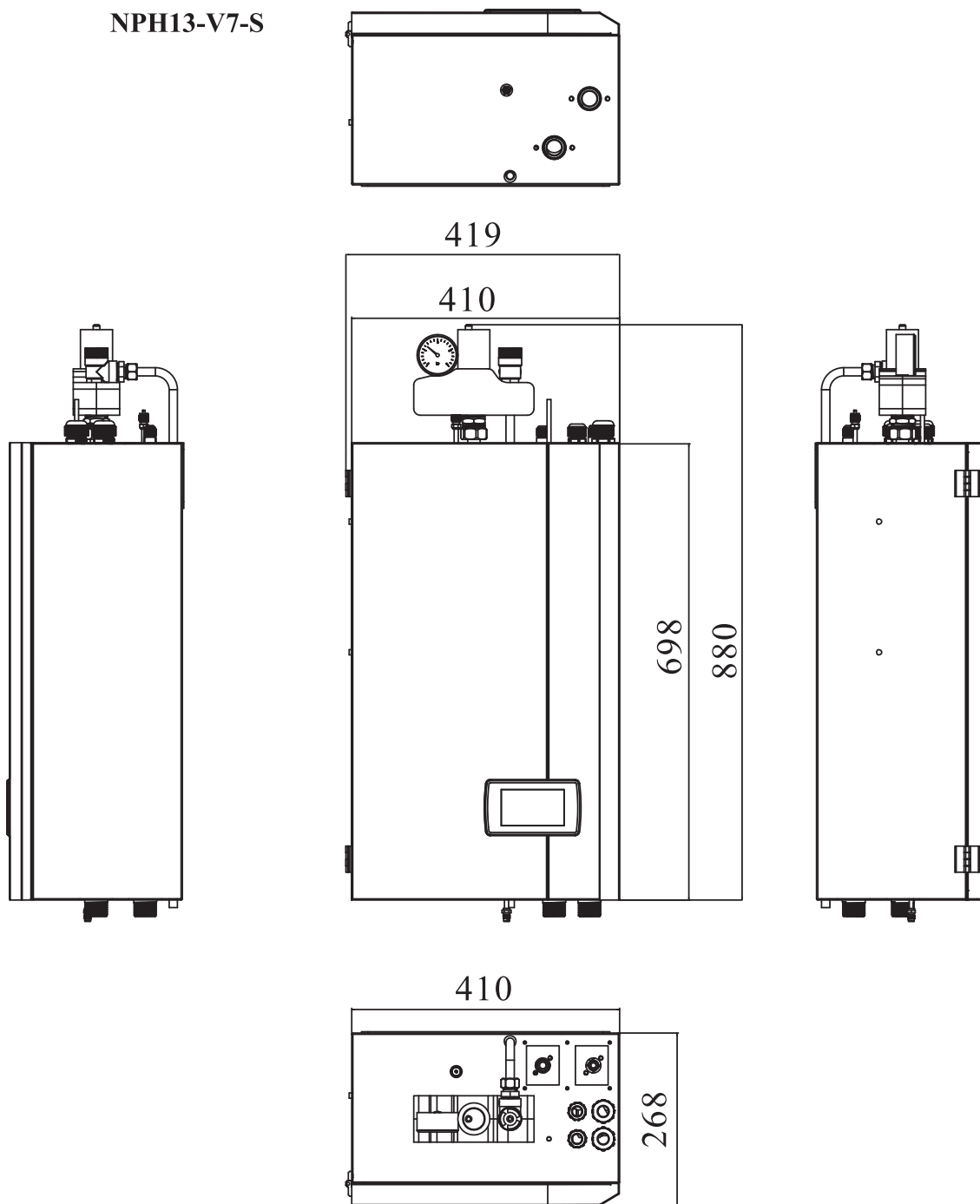



## 2. Overview of the Units

### 2.2.Outlines and Dimensions

Outdoor — NP6-V7-S

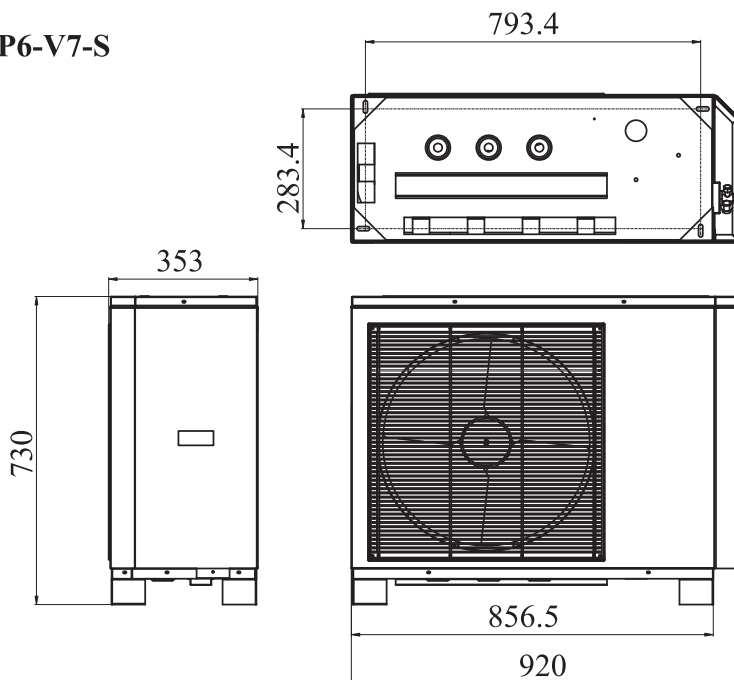

Unit:mm

Refrigerant connector  
dimension:NPH6-V7-S: 1/4" and 1/2"

Outdoor — NP9-V7-S

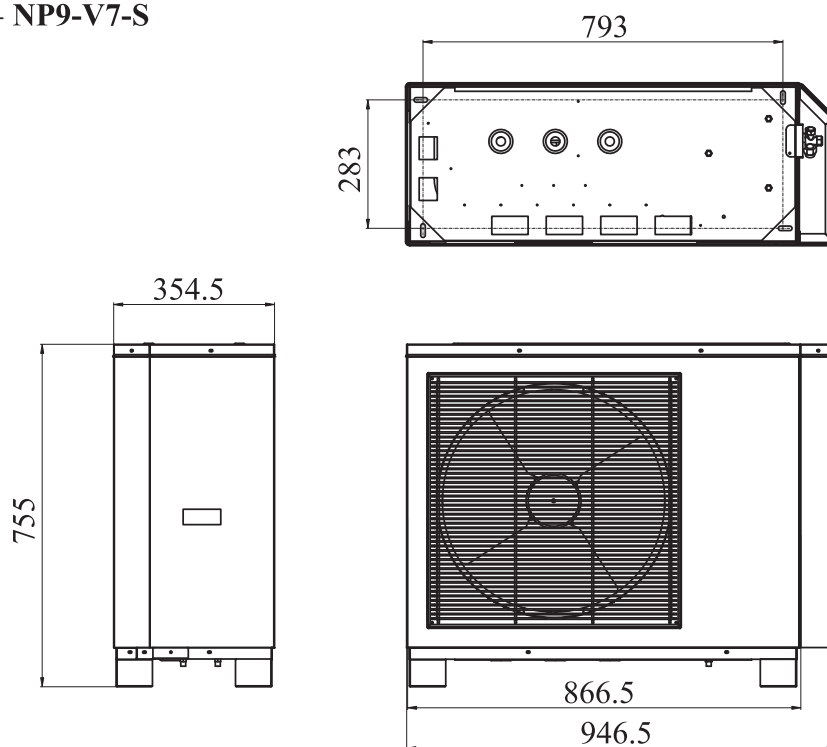

Unit:mm

Refrigerant connector  
dimension:NPH9-V7-S: 3/8" and 1/2"

## 2. Overview of the Units

### 2.2.Outlines and Dimensions

Outdoor —— NP11-V7-S

Unit:mm

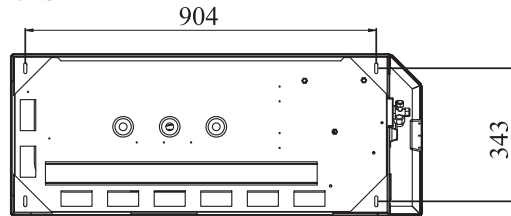

Refrigerant connector  
dimension:3/8" and 1/2"

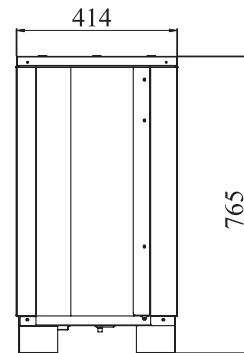
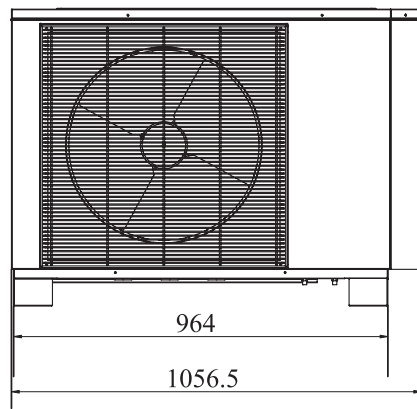

Outdoor —— NP13-V7-S

Unit:mm

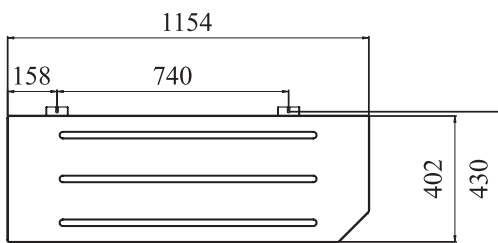
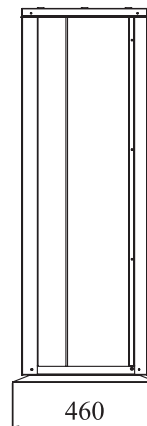
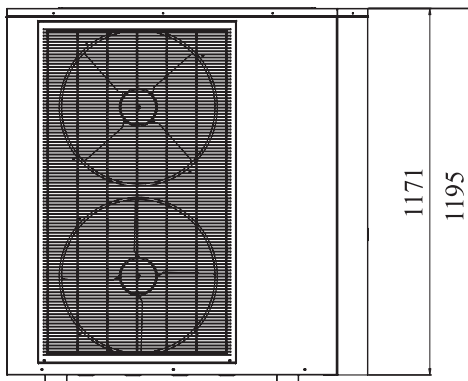

Refrigerant connector  
dimension:3/8" and 5/8"

## 2. Overview of the Units

### 2.3. Exploded view

Indoor ———  
 NPH6-V7-S  
 NPH9-V7-S  
 NPH11-V7-S  
 NPH13-V7-S

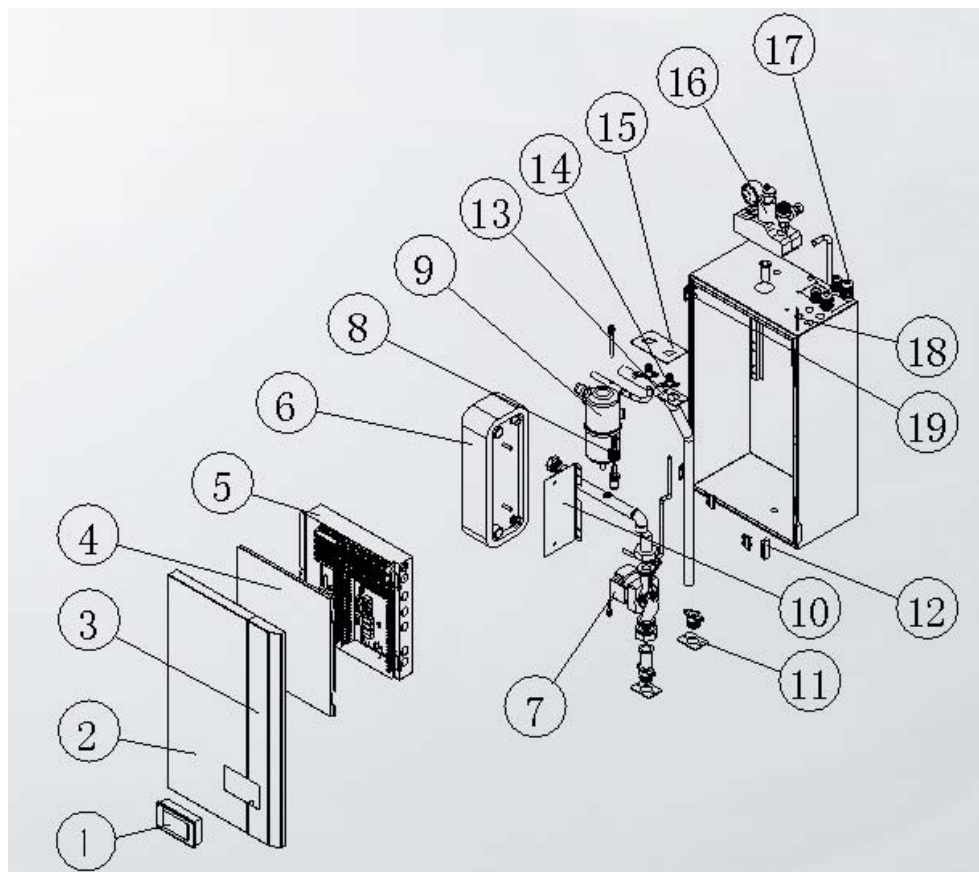

NO	Name	NO	Name
1	Operation panel	11	Insulation panel
2	Decorative panel	12	Magnet
3	Door	13	Sensor fixture
4	Electric box cover	14	Needle valve for service
5	Electric box	15	Plate for refrigerant connector
6	Plate heat exchanger	16	Air purging valve
7	Water pump	17	Cable gland
8	Water flow switch	18	WIFI antenna
9	Refrigerant expansion tank	19	Hinge
10	Fixture of plate heat exchanger		

## 2. Overview of the Units

### 2.3. Exploded view

Outdoor — NP6-V7-S  
NP9-V7-S  
NP11-V7-S

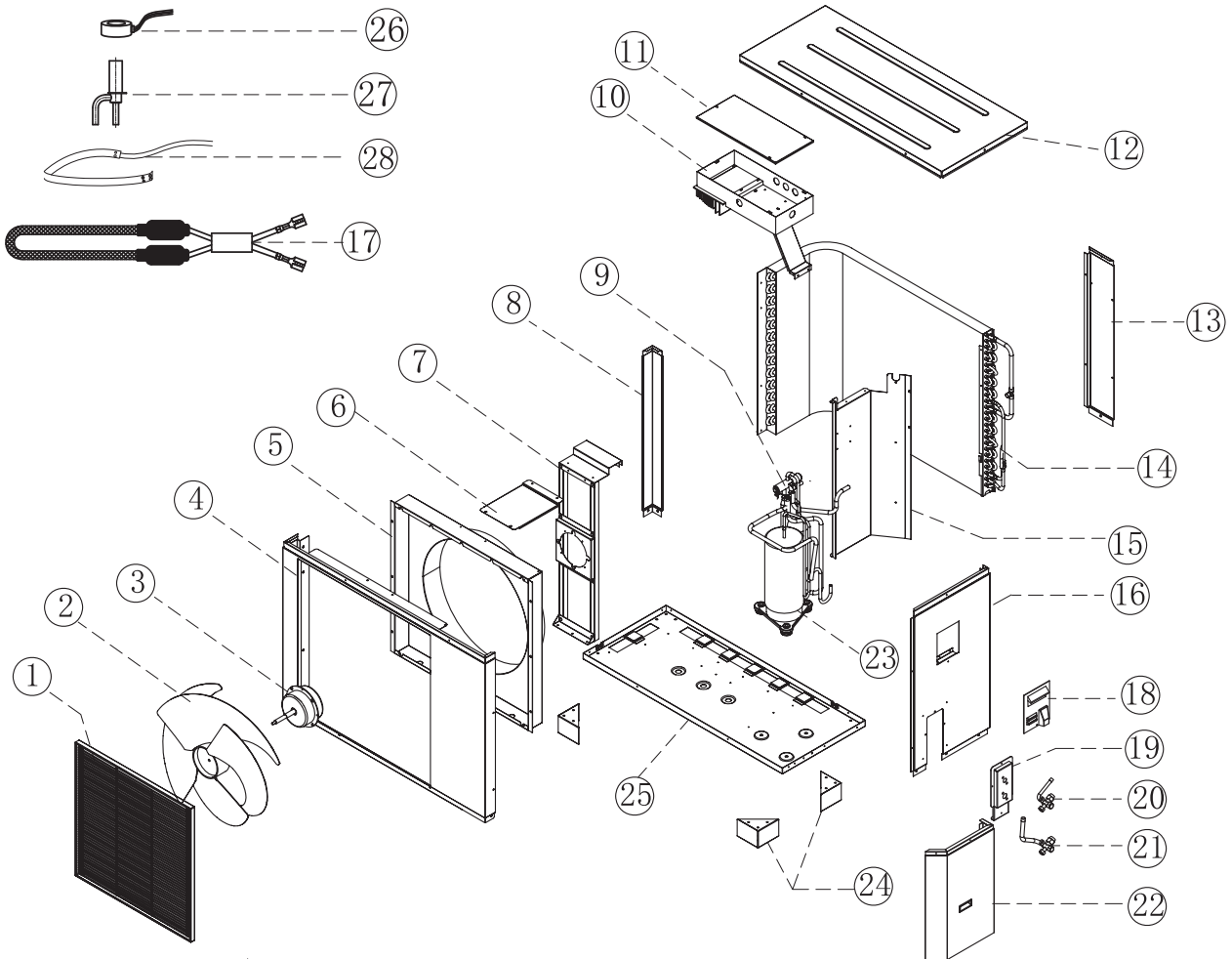

NO	Name	NO	Name	NO	Name
1	Decorative panel	11	Electric box cover	20	1/4" Valve-NP6-V7-S
2	Outdoor fan	12	Top panel		3/8" Valve-NP9/11-V7-S
3	Outdoor motor	13	Back panel	21	1/2" Valve
4	Front panel	14	Condenser	22	Side decorative panel
5	Air guide	15	Bulkhead	23	Compressor
6	Fixture	16	Right plate	24	Feet
7	Motor bracket	17	Condebser heater	25	Bottom plate
8	Column support	18	Big handle	26	Eev coil
9	Four-way valve	19	Bulkhead	27	Electrical expansion valve
10	Electrical box			28	Compressor heater

## 2. Overview of the Units

### 2.3. Exploded view

Outdoor — NP13-V7-S

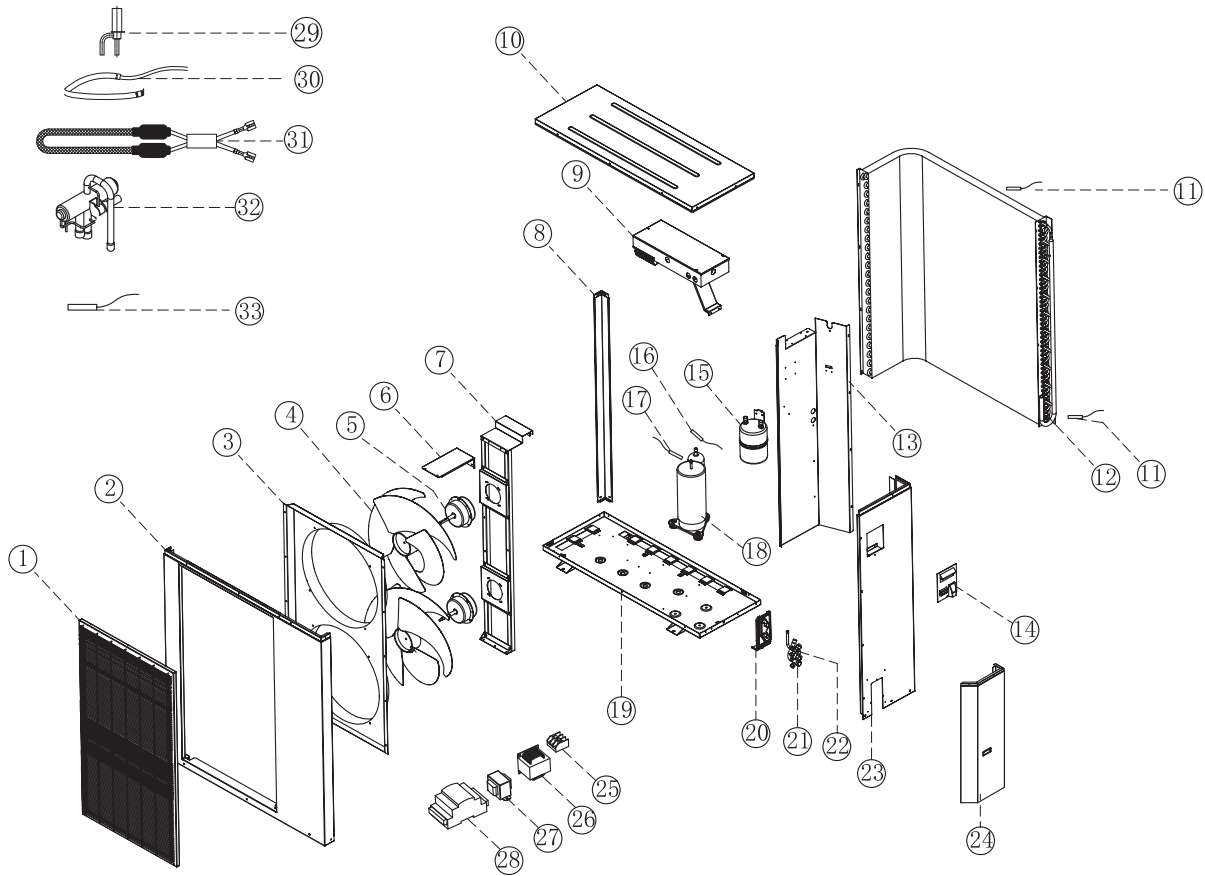

NO	Name	NO	Name	NO	Name
1	Decorative panel	12	Condenser	23	Side panel
2	Front panel	13	Bulkhead	24	Side decorative panel
3	Air guide	14	Handle	25	Terminal block
4	Outdoor fan	15	Sperator	26	PFC transducer
5	Outdoor motor	16	Suction temperature sensor	27	Transformer
6	Fixture	17	Compressor discharge temperature sensor	28	EEV controller
7	Motor bracket			29	Electronic expansion valve
8	Column support	18	Compressor	30	Crankcase heater
9	Controller	19	Bottom plate	31	Condenser heater
10	Top panel	20	Valve plate	32	4-Way valve
11	Coil and ambient temperature sensor	21	5/8" Valve	33	EEV temperature sensor
		22	3/8" Valve		

# Locate the Configuration that Meets Your Needs

## 3. Assembly Configurations - Flowchart

Follow the flowchart on the right in order to locate which of the assembly configuration matches the needs of the end user, each of which contains specific assembly and wiring diagrams, with software instructions.

Beginning from the green "Start Here" bubble, follow the appropriate arrows to each question, which are dependent on the needs of the user.

The corresponding assembly instructions will be found by turning to the page number in the end bubble.

**Note:** *The instructions in this section are meant to achieve the minimum requirements for successful system operation only.*

*For more in-depth settings explanations, please refer to the user's manual.*

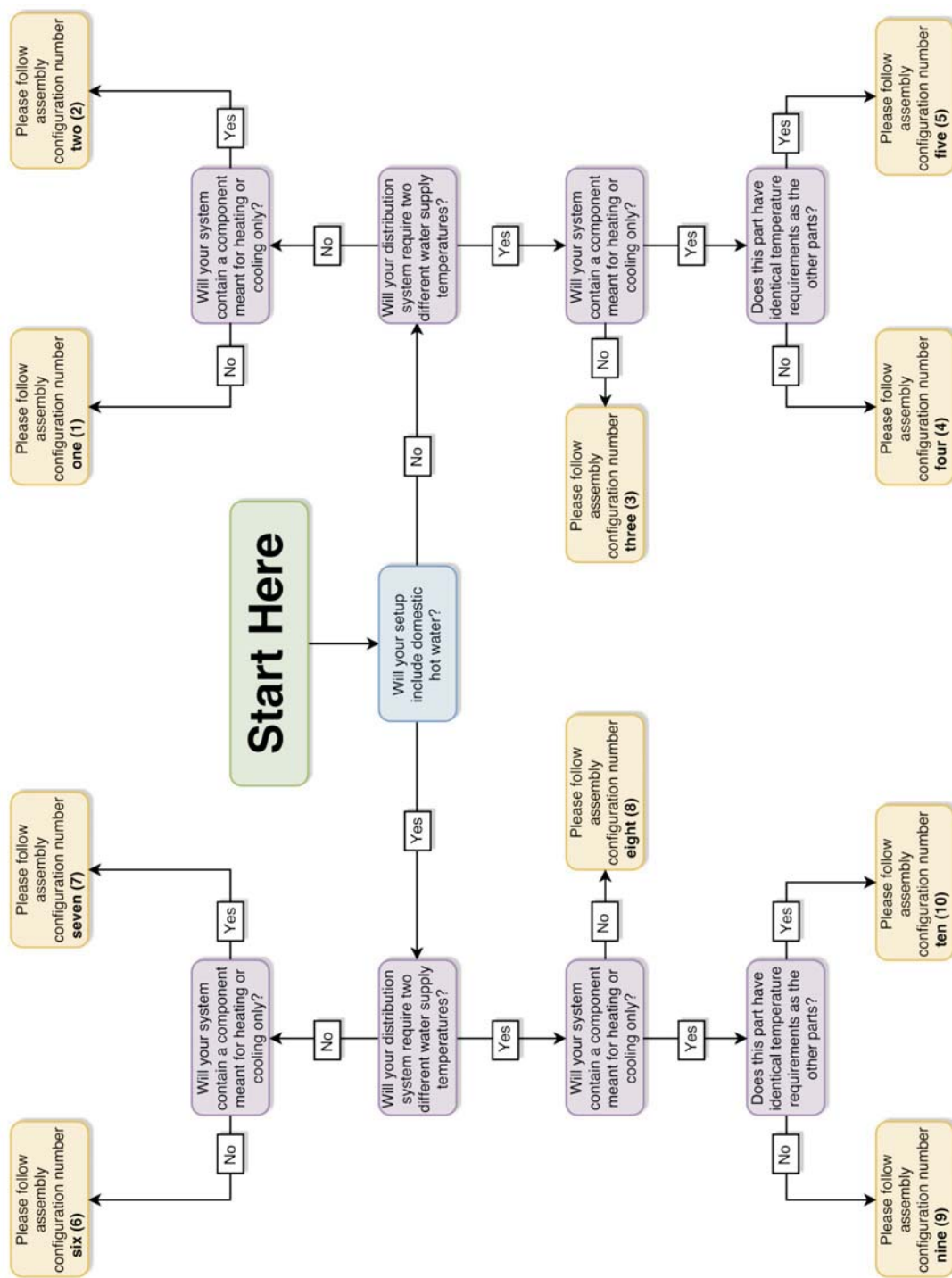

# 3. Assembly Configurations – Drawing 1

Please ensure that the configuration matches the assembly drawing depicted on the right for a one temperature zone without domestic hot water setup.

*Note: Refer to the next page for wiring and software operation instructions.*

Name	Symbol	Name	Symbol
Temp. Sensor		Water pump	
Safety valve Kit		Mixing valve	
Ball valve		Motorized valve	
Water filter		Expansion tank	
Air purging valve			

Note: Dotted lines mean "able to be controlled by the Heat Pump".

*Notice: The Fan Coil Unit, Floor Heating System, and Radiator are placeholder distribution systems only and can be substituted by any other appropriate distribution systems.*

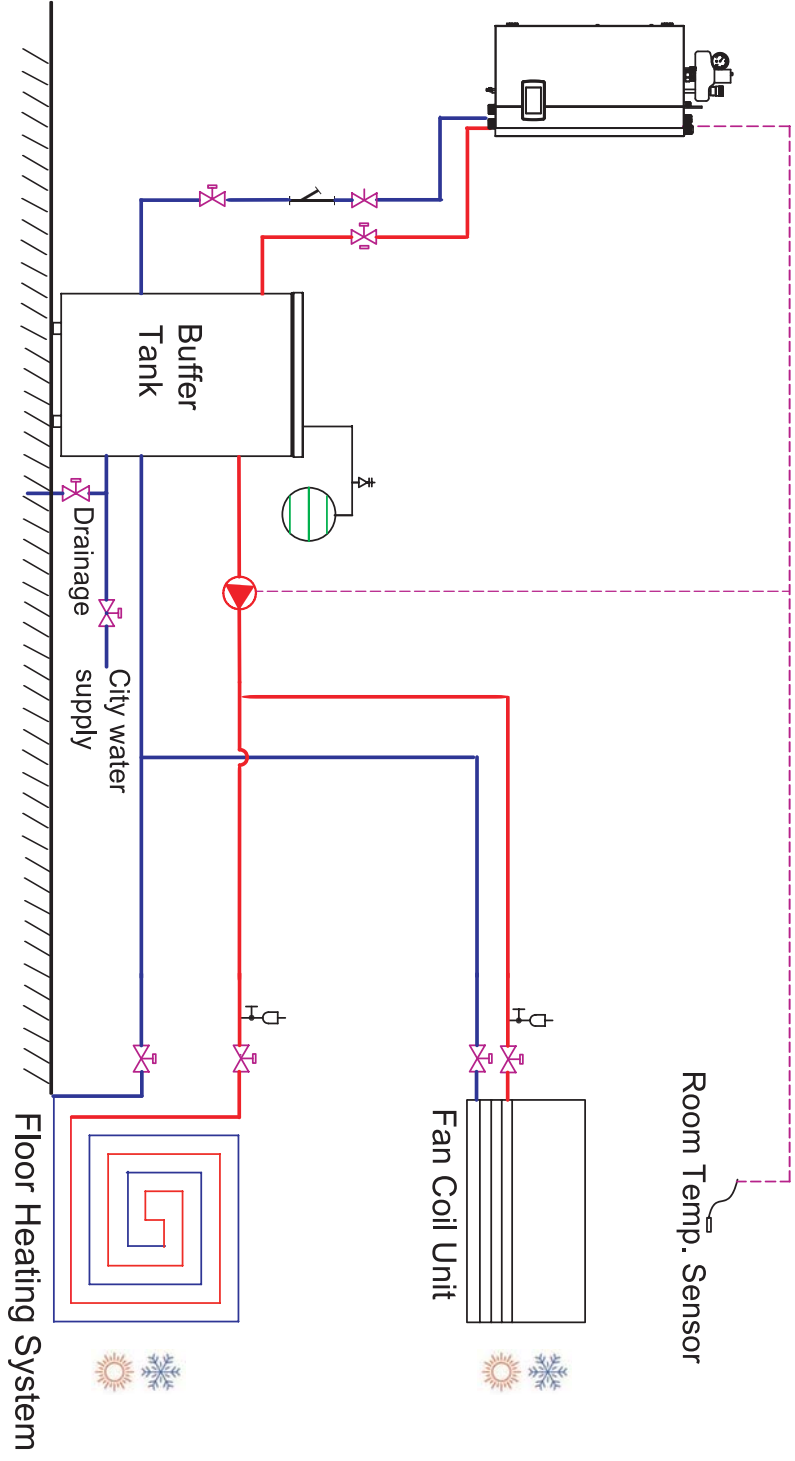

One Temperature Zone, without DHW

# 3. Assembly Configurations – Drawing 1

## Assembly 1: Wiring Diagram

To achieve successful operation at a minimum, ensure the ports below are properly connected.

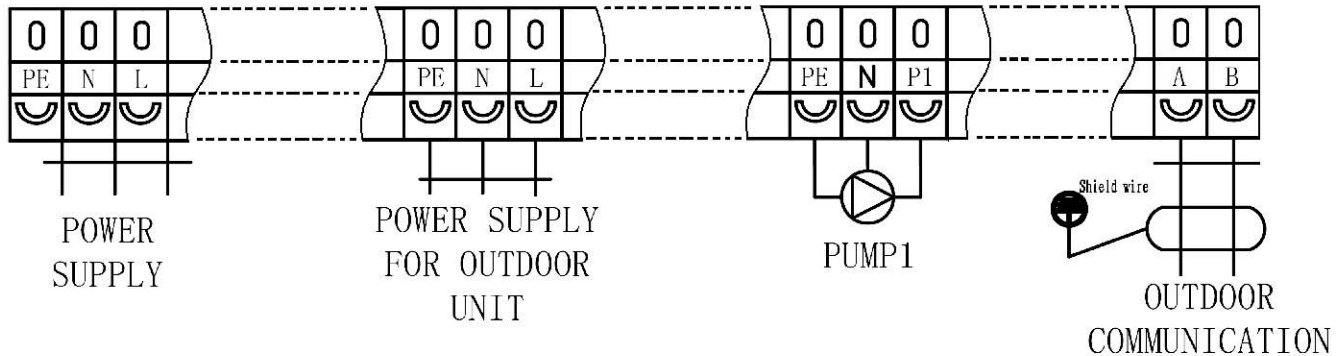

## Software: Basic Settings

1. Set the needed working modes of the unit via the menu

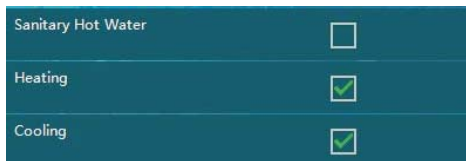
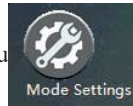

2. Temperature configuration options for Heating/Cooling circuit 1 are found under



**H.** Configuring the set water heating temperatures:

**H.1.** Setting a heating curve:



Ambient Temp. 1	-25°C	Water Temp. A/Ambient Temp. 1	40°C
Ambient Temp. 2	-15°C	Water Temp. B/Ambient Temp. 2	37°C
Ambient Temp. 3	-5°C	Water Temp. C/Ambient Temp. 3	33°C
Ambient Temp. 4	5°C	Water Temp. D/Ambient Temp. 4	29°C
Ambient Temp. 5	10°C	Water Temp. E/Ambient Temp. 5	25°C

**H.2.** If no heating curve is desired:

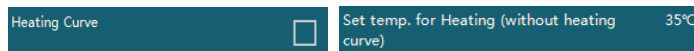

**C.** Configuring the set water cooling temperature (if applicable):

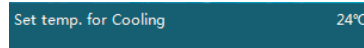

If cooling function is desired, ensure these sections are configured.

3. Locate and activate the buffer tank and appropriate pumps under

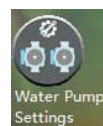



### 3. Assembly Configurations – Drawing 2

Please ensure that the configuration matches the assembly drawing depicted on the right for a one temperature zone without domestic hot water setup, that includes a component circuit capable of heating or cooling only, through the use of a two-way motorized valve.

*Note:* For the cooling-only or heating-only circuit, a motorized two-way valve can be connected to the unit, to cut the water supply during heating or cooling operation.

Refer to the next page for wiring and software operation instructions.

Name	Symbol	Name	Symbol
Temp. Sensor		Water pump	
Safety valve Kit		Mixing valve	
Ball valve		Motorized valve	
Water filter		Expansion tank	
Air purging valve			

*Note:* Dotted lines mean "able to be controlled by the Heat Pump".

*Notice: The Fan Coil Unit, Floor Heating System, and Radiator are placeholder distribution systems only and can be substituted by any other appropriate distribution systems.*

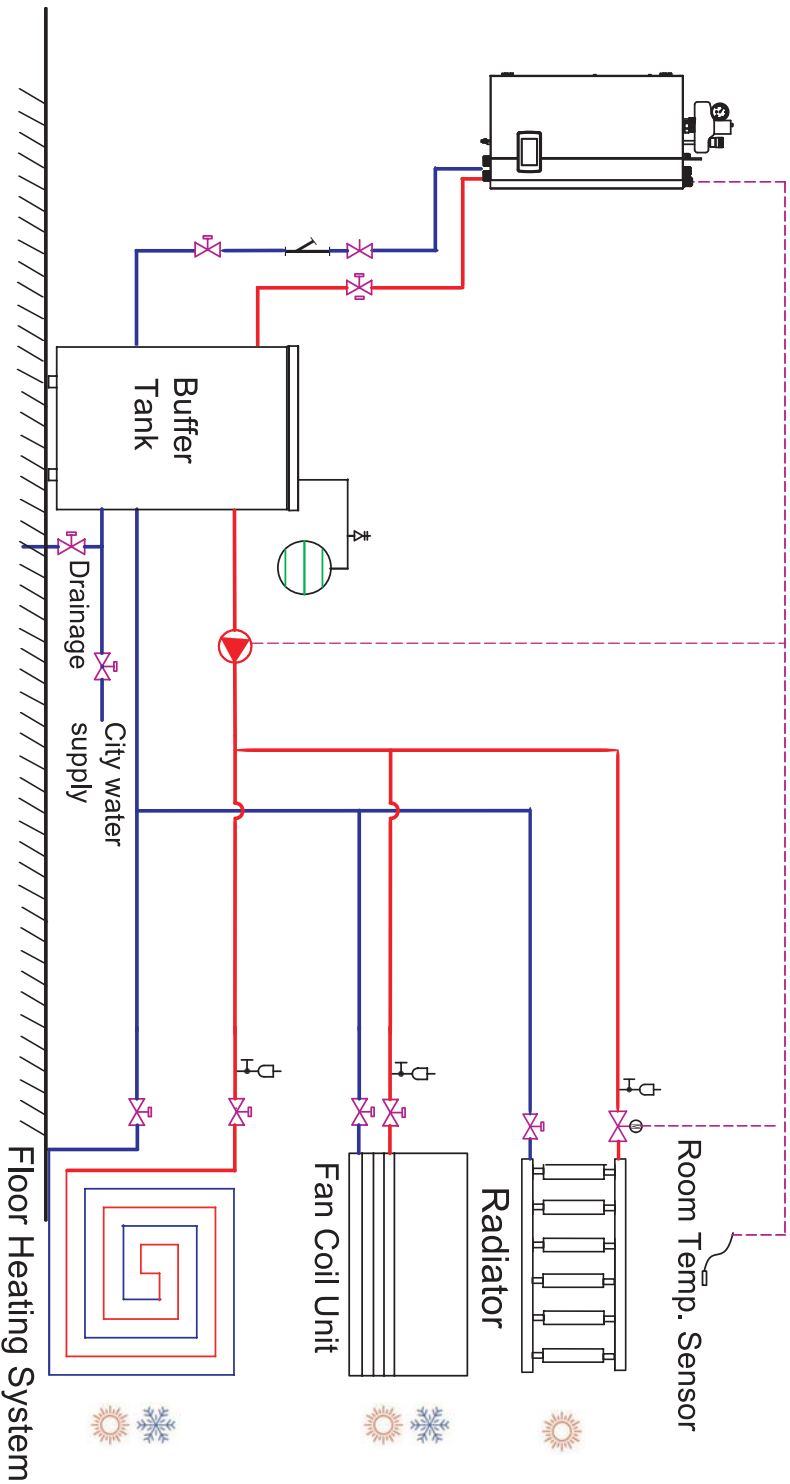

One Temperature Zone, without DHW, with a heating-only (or cooling-only) circuit, by usage of a motorized 2-way valve

# 3. Assembly Configurations – Drawing 2

## Assembly 2: Wiring Diagram

To achieve successful operation at a minimum, ensure the ports below are properly connected.

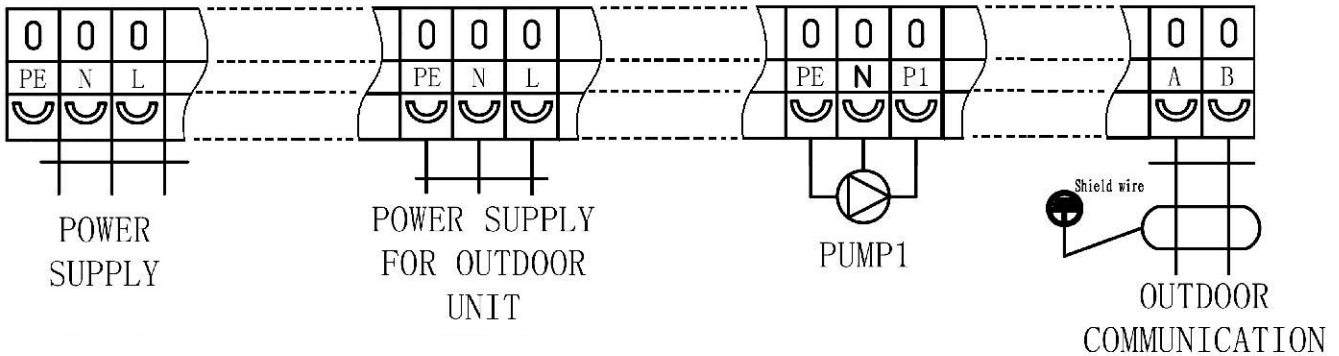

## Software: Basic Settings

1. Set the needed working modes of the unit via the menu

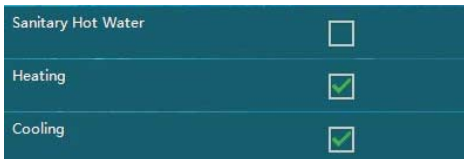
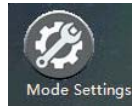

2. Temperature configuration options for Heating/Cooling circuit 1 are found under

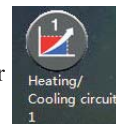

**H.** Configuring the set water heating temperatures:

**H.1.** Setting a heating curve:



Ambient Temp. 1	-25°C
Ambient Temp. 2	-15°C
Ambient Temp. 3	-5°C
Ambient Temp. 4	5°C
Ambient Temp. 5	10°C

Water Temp. A/Ambient Temp. 1	40°C
Water Temp. B/Ambient Temp. 2	37°C
Water Temp. C/Ambient Temp. 3	33°C
Water Temp. D/Ambient Temp. 4	29°C
Water Temp. E/Ambient Temp. 5	25°C

**H.2.** If no heating curve is desired:

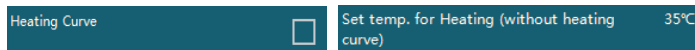

**C.** Configuring the set water cooling temperature (if applicable):



If cooling function is desired, ensure these sections are configured.

3. Locate and activate the buffer tank and appropriate pumps under

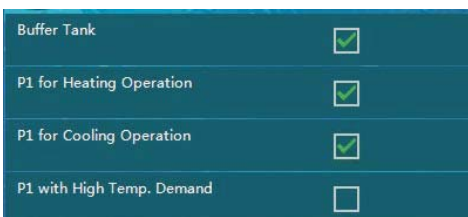

### 3. Assembly Configurations – Drawing 2

---

#### Software: Basic Settings (continued)

4. The location of the configuration for heating-only or cooling-only system is under

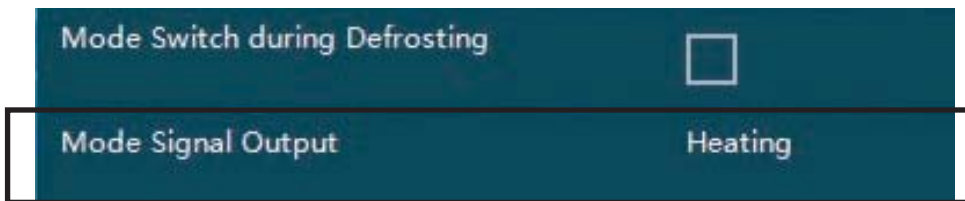

### 3. Assembly Configurations – Drawing 3

*Notice: The Fan Coil Unit, Floor Heating System, and Radiator are placeholder distribution systems only and can be substituted by any other appropriate distribution systems.*

Name	Symbol	Name	Symbol
Temp. Sensor		Water pump	
Safety valve Kit		Mixing valve	
Ball valve		Motorized valve	
Water filter		Expansion tank	
Air purging valve			

Note: Dotted lines mean "able to be controlled by the Heat Pump".

Please ensure that the configuration matches the assembly drawing depicted on the right for a two temperature zone without domestic hot water setup.

Note: Refer to the next page for wiring and software operation instructions.

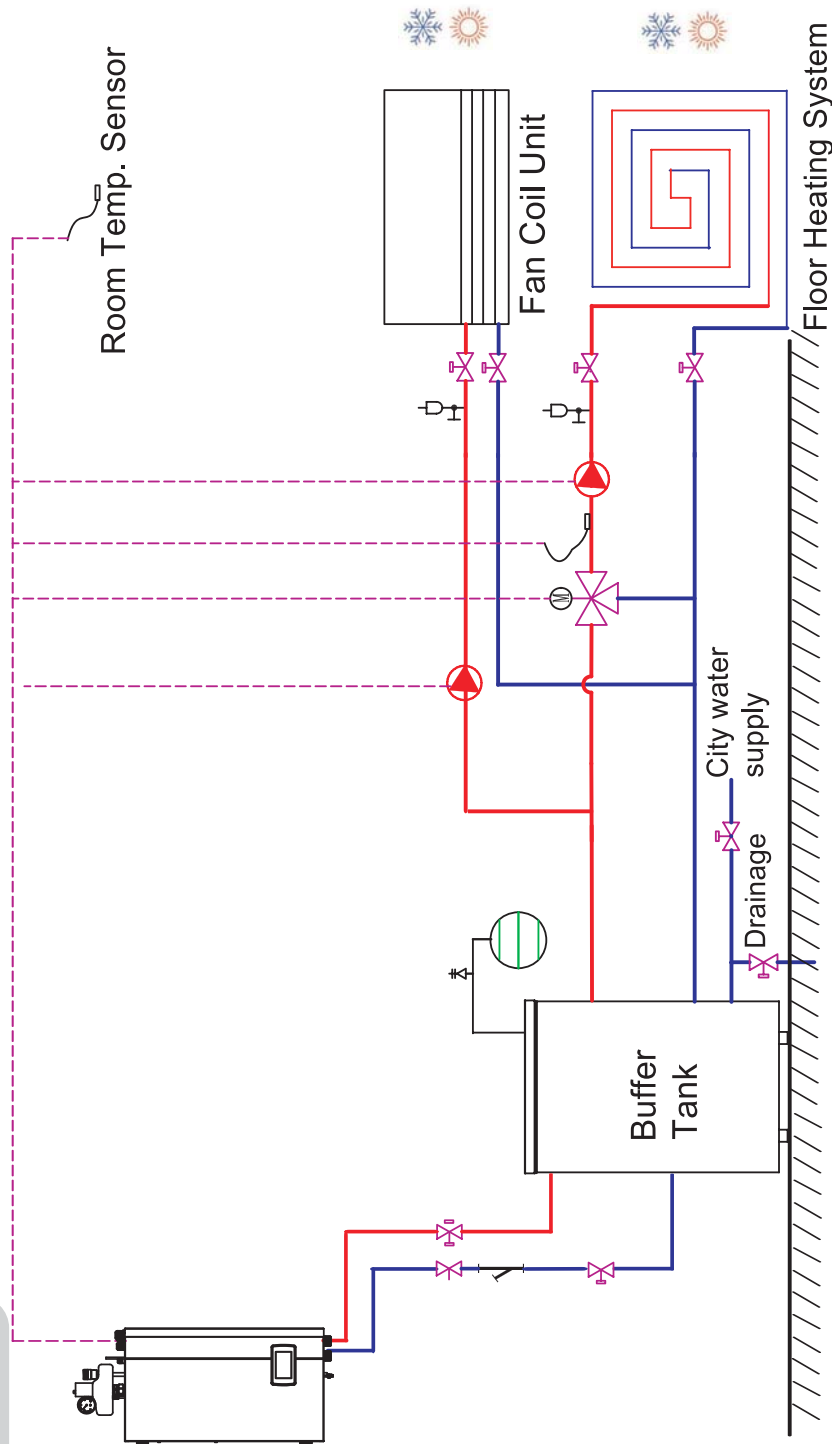

Two Temperature Zones , without DHW

# 3. Assembly Configurations – Drawing 3

## Assembly 3: Wiring Diagram

To achieve successful operation at a minimum, ensure the ports below are properly connected.

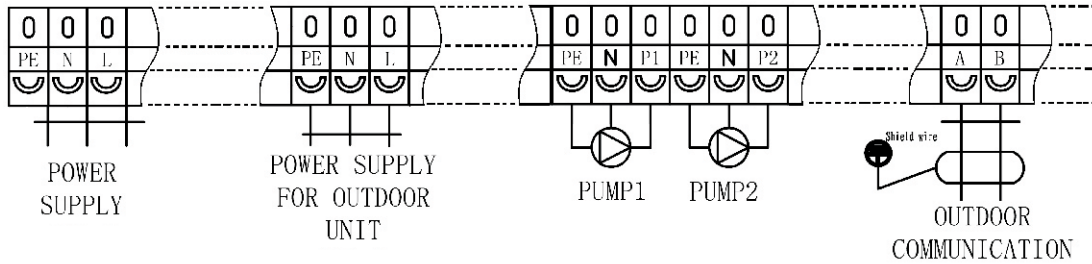

For connection for mixing valve 2, please refer to the appendix A (on page 78-79) of this manual for more information.

## Software: Basic Settings

1. Set the needed working modes of the unit via the menu

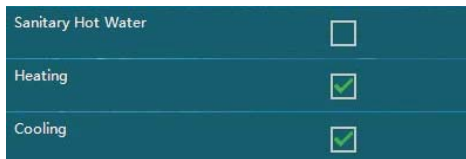
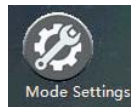

2. Temperature configuration options for Heating/Cooling circuit 1 are found under



H. Configuring the set water heating temperatures:

H.1. Setting a heating curve:



Ambient Temp. 1	-25°C
Ambient Temp. 2	-15°C
Ambient Temp. 3	-5°C
Ambient Temp. 4	5°C
Ambient Temp. 5	10°C

Water Temp. A/Ambient Temp. 1	40°C
Water Temp. B/Ambient Temp. 2	37°C
Water Temp. C/Ambient Temp. 3	33°C
Water Temp. D/Ambient Temp. 4	29°C
Water Temp. E/Ambient Temp. 5	25°C

H.2. If no heating curve is desired:

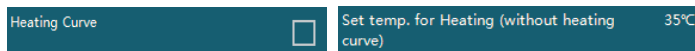

C. Configuring the set water cooling temperature (if applicable):

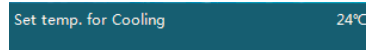

If cooling function is desired, ensure these sections are configured.

3. Locate and activate the buffer tank and appropriate pumps under

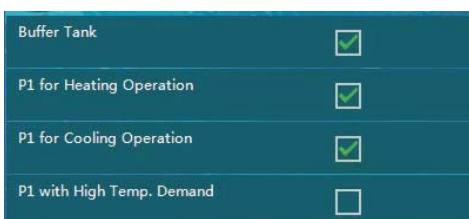
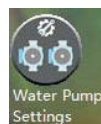

# 3. Assembly Configurations – Drawing 3

## Software: Basic Settings (continued)

3.(cont.) Configure the water pump to operate for heating or cooling:

P2 for Heating Operation

P2 for Cooling Operation



4. Temperature configuration options for Heating/Cooling circuit 2 are found under  
Please activate entire Heating/Cooling circuit 2 setting

Heatingcooling Circuit 2

H. Configuring the set water heating temperatures:

H.1. Setting a heating curve:

Heating Curve

Water Temp. A/Ambient Temp. 1	40°C
Water Temp. B/Ambient Temp. 2	37°C
Water Temp. C/Ambient Temp. 3	33°C
Water Temp. D/Ambient Temp. 4	29°C
Water Temp. E/Ambient Temp. 5	25°C

H.2. If no heating curve is desired:

Heating Curve

Set Temp. for Heating (without heating curve) 35°C

C. Configuring the set water cooling temperature (if applicable):

Set temp. For Cooling 24°C



4.1. Activate the mixing valve to manage the second circuit:

Mixing Valve

*Note: This pair of settings will interpret “Heating/Cooling Circuit 2 as the low demand distribution system, requiring a lower set temperature for heating and higher set temperature for cooling.*

Dependent on whether cooling is needed

### 3. Assembly Configurations – Drawing 4

Please ensure that the configuration matches the assembly drawing depicted on the right for a two temperature zone without domestic hot water setup, that includes a component circuit capable of heating or cooling only through the use of a two-way motorized valve.

*Note: For the cooling-only or heating-only circuit, a motorized two-way valve can be connected to the unit, to cut the water supply during heating or cooling operation.*

*Refer to the next page for wiring and software operation instructions.*

Name	Symbol	Name	Symbol
Temp. Sensor		Water pump	
Safety valve Kit		Mixing valve	
Ball valve		Motorized valve	
Water filter		Expansion tank	
Air purging valve			

*Note: Dotted lines mean "able to be controlled by the Heat Pump".*

*Notice: The Fan Coil Unit, Floor Heating System, and Radiator are placeholder distribution systems only and can be substituted by any other appropriate distribution systems.*

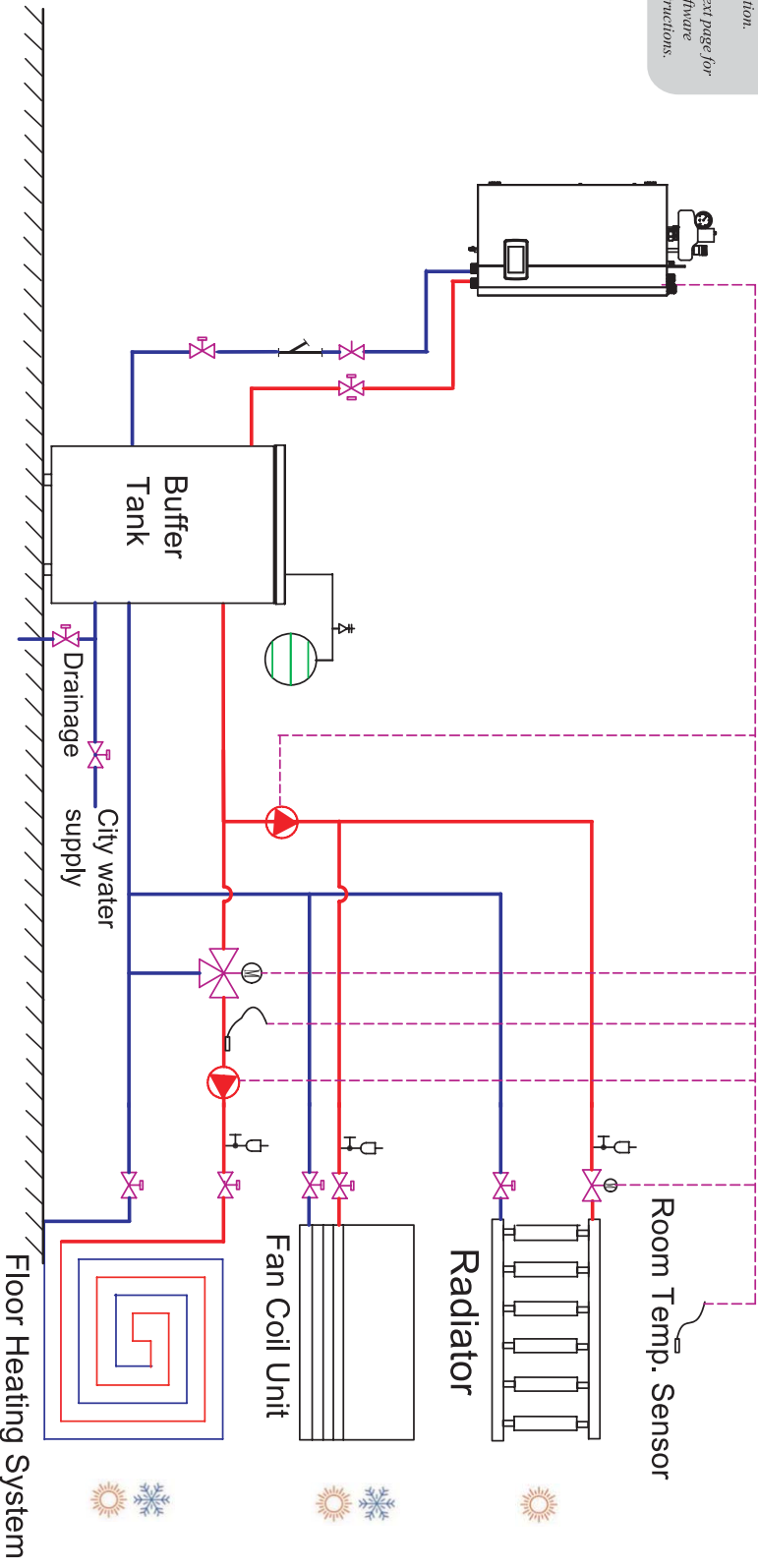

Two Temperature Zones , without DHW, with a heating-only (or cooling-only) circuit, by usage of a motorized 2-way valve

# 3. Assembly Configurations – Drawing 4

## Assembly 4: Wiring Diagram

To achieve successful operation at a minimum, ensure the ports below are properly connected.

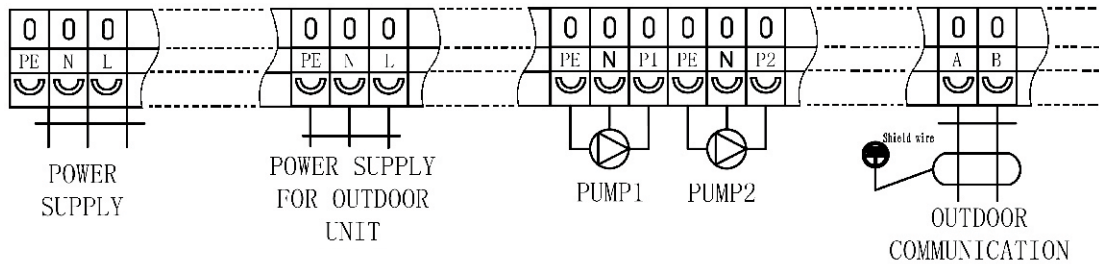

For connection for mixing valve 2, please refer to the appendix A (on page 78-79) of this manual for more information.

## Software: Basic Settings

1. Set the needed working modes of the unit via the menu

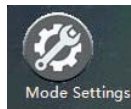

Sanitary Hot Water	<input type="checkbox"/>
Heating	<input checked="" type="checkbox"/>
Cooling	<input checked="" type="checkbox"/>

2. Temperature configuration options for Heating/Cooling circuit 1 are found under



**H.** Configuring the set water heating temperatures:

**H.1.** Setting a heating curve:

Heating Curve	<input checked="" type="checkbox"/>
---------------	-------------------------------------

Ambient Temp. 1	-25°C
Ambient Temp. 2	-15°C
Ambient Temp. 3	-5°C
Ambient Temp. 4	5°C
Ambient Temp. 5	10°C

Water Temp. A/Ambient Temp. 1	40°C
Water Temp. B/Ambient Temp. 2	37°C
Water Temp. C/Ambient Temp. 3	33°C
Water Temp. D/Ambient Temp. 4	29°C
Water Temp. E/Ambient Temp. 5	25°C

**H.2.** If no heating curve is desired:

Heating Curve	<input type="checkbox"/>	Set temp. for Heating (without heating curve)	35°C
---------------	--------------------------	---	------

**C.** Configuring the set water cooling temperature (if applicable):

Set temp. for Cooling	24°C
-----------------------	------

If cooling function is desired, ensure these sections are configured.

3. Locate and activate the buffer tank and appropriate pumps under



Buffer Tank	<input checked="" type="checkbox"/>
P1 for Heating Operation	<input checked="" type="checkbox"/>
P1 for Cooling Operation	<input checked="" type="checkbox"/>
P1 with High Temp. Demand	<input type="checkbox"/>



### 3. Assembly Configurations – Drawing 4

#### Software: Basic Settings (continued)

3.(cont.) Configure the water pump to operate for heating or cooling:

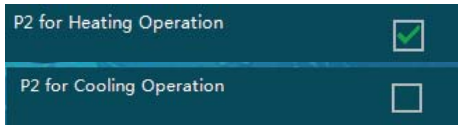

4. The location of the configuration for heating-only or cooling-only system is under

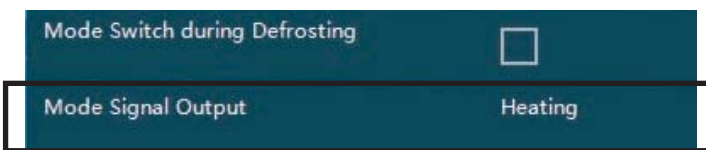
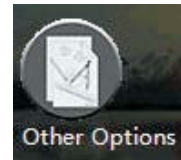

5. Temperature configuration options for Heating/Cooling circuit 2 are found under



H. Configuring the set water heating temperatures:

H.1. Setting a heating curve:



Water Temp. A/Ambient Temp. 1	40°C
Water Temp. B/Ambient Temp. 2	37°C
Water Temp. C/Ambient Temp. 3	33°C
Water Temp. D/Ambient Temp. 4	29°C
Water Temp. E/Ambient Temp. 5	25°C

H.2. If no heating curve is desired:



Set Temp. for Heating (without heating curve)	35°C
---	------

C. Configuring the set water cooling temperature (if applicable):



5.1. Activate the mixing valve to manage the second circuit:



Note: This pair of settings will interpret “Heating/Cooling Circuit 2 as the low demand distribution system, requiring a lower set temperature for heating and higher set temperature for cooling.

Dependent on whether cooling is needed

# 3. Assembly Configurations – Drawing 5

*Notice: The Fan Coil Unit, Floor Heating System, and Radiator are placeholder distribution systems only and can be substituted by any other appropriate distribution systems.*

Name	Symbol	Name	Symbol
Temp. Sensor		Water pump	
Safety valve Kit		Mixing valve	
Ball valve		Motorized valve	
Water filter		Expansion tank	
Air purging valve			

Note: Dotted lines mean "able to be controlled by the Heat Pump"

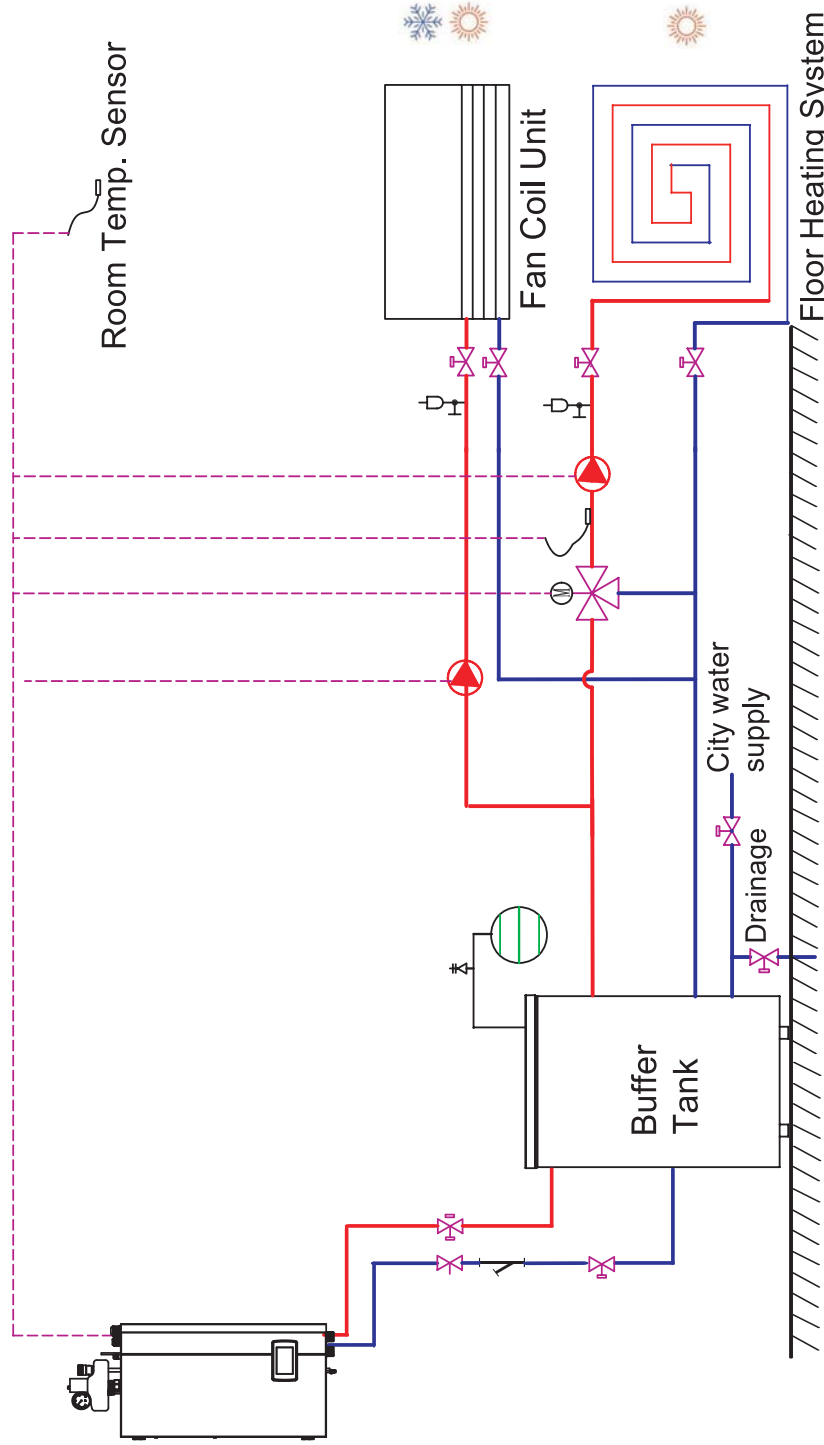

Please ensure that the configuration matches the assembly drawing depicted on the right for a two temperature zone without domestic hot water setup, that utilizes the secondary pump for a heating-only operation.

Note: For the heating-only circuit, a motorized two-way valve can be connected to the unit, to cut the water supply during heating operation.

Refer to the next page for wiring and software operation instructions.

Two Temperature Zones , without DHW, with a heating-only circuit, enabled by setting the secondary pump to heating-only

# 3. Assembly Configurations – Drawing 5

## Assembly 5: Wiring Diagram

To achieve successful operation at a minimum, ensure the ports below are properly connected.

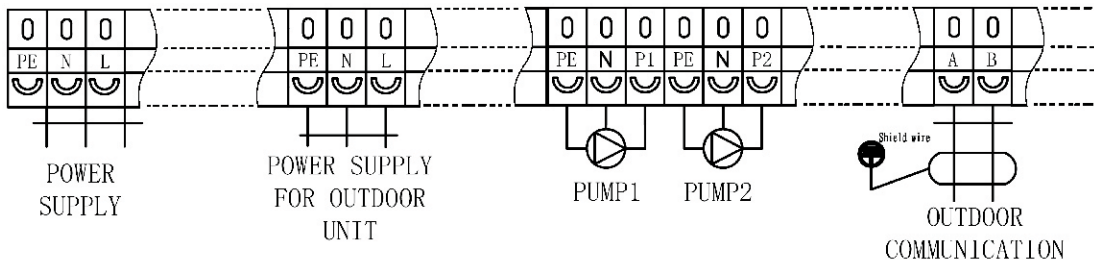

For connection for mixing valve 2, please refer to the appendix A (on page 78-79) of this manual for more information.

## Software: Basic Settings

1. Set the needed working modes of the unit via the menu

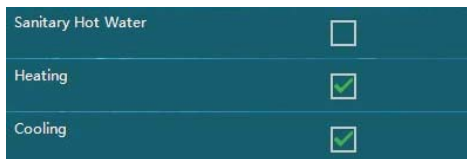
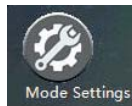

2. Temperature configuration options for Heating/Cooling circuit 1 are found under



**H.** Configuring the set water heating temperatures:

**H.1.** Setting a heating curve:



Ambient Temp. 1	-25°C	Water Temp. A/Ambient Temp. 1	40°C
Ambient Temp. 2	-15°C	Water Temp. B/Ambient Temp. 2	37°C
Ambient Temp. 3	-5°C	Water Temp. C/Ambient Temp. 3	33°C
Ambient Temp. 4	5°C	Water Temp. D/Ambient Temp. 4	29°C
Ambient Temp. 5	10°C	Water Temp. E/Ambient Temp. 5	25°C

**H.2.** If no heating curve is desired:

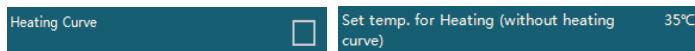

**C.** Configuring the set water cooling temperature (if applicable):



If cooling function is desired, ensure these sections are configured.

3. Locate and activate the buffer tank and appropriate pumps under

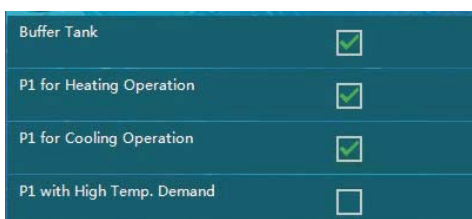
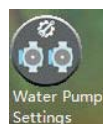

# 3. Assembly Configurations – Drawing 5

## Software: Basic Settings (continued)

3.(cont.) Configure the water pump to operate for heating or cooling:



4. Temperature configuration options for Heating/Cooling circuit 2 are found under



H. Configuring the set water heating temperatures:

H.1. Setting a heating curve:



Water Temp. A/Ambient Temp. 1	40°C
Water Temp. B/Ambient Temp. 2	37°C
Water Temp. C/Ambient Temp. 3	33°C
Water Temp. D/Ambient Temp. 4	29°C
Water Temp. E/Ambient Temp. 5	25°C

H.2. If no heating curve is desired:



Set Temp. for Heating (without heating curve)	35°C
---	------

C. Configuring the set water cooling temperature (if applicable):



4.1. Activate the mixing valve to manage the second circuit:



*Note: This pair of settings will interpret “Heating/Cooling Circuit 2 as the low demand distribution system, requiring a lower set temperature for heating and higher set temperature for cooling.*

### 3. Assembly Configurations – Drawing 6

Please ensure that the configuration matches the assembly drawing depicted on the right for a one temperature zone setup that includes domestic hot water.

*Note: Refer to the next page for wiring and software operation instructions.*

Name	Symbol	Name	Symbol
Temp. Sensor		Water pump	
Safety valve Kit		Mixing valve	
Ball valve		Motorized valve	
Water filter		Expansion tank	
Air purging valve			

*Note: Dotted lines mean "able to be controlled by the Heat Pump". distribution systems.*

*Notice: The Fan Coil Unit, Floor Heating System, and Radiator are placeholder distribution systems only and can be substituted by any other appropriate*

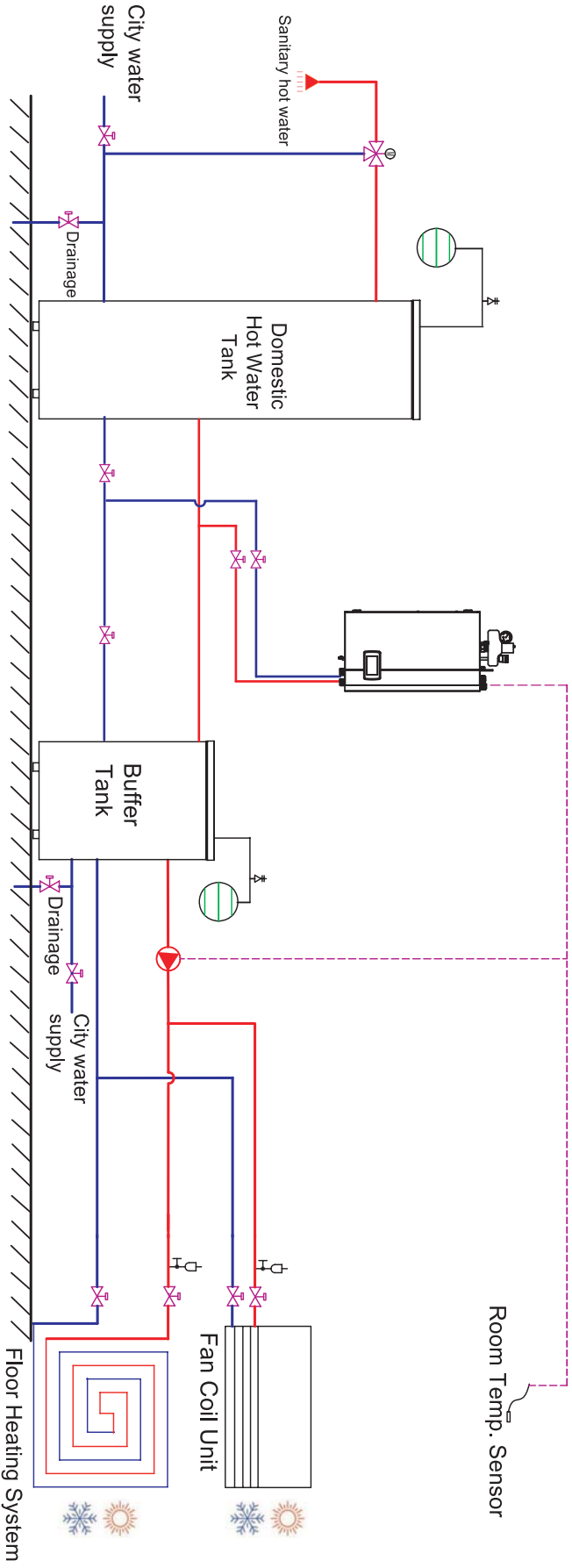

One Temperature Zone, with DHW

# 3. Assembly Configurations – Drawing 6

## Assembly 6: Wiring Diagram

To achieve successful operation at a minimum, ensure the ports below are properly connected.

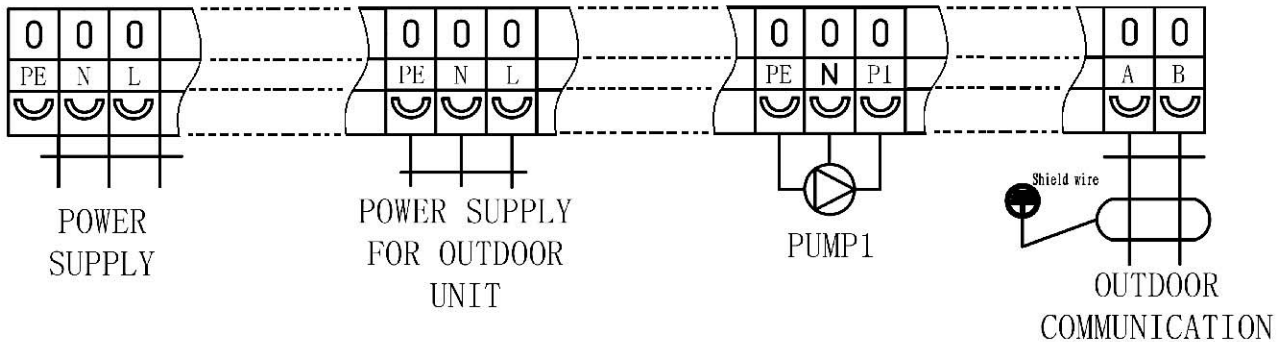

## Software: Basic Settings

1. Set the needed working modes of the unit via the menu

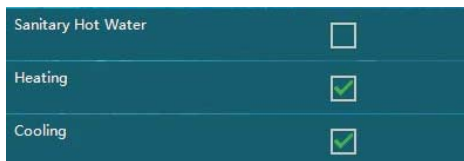
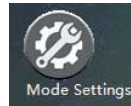

2. Temperature configuration options for Heating/Cooling circuit 1 are found under

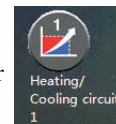

**H.** Configuring the set water heating temperatures:

**H.1.** Setting a heating curve:



Ambient Temp. 1	-25°C
Ambient Temp. 2	-15°C
Ambient Temp. 3	-5°C
Ambient Temp. 4	5°C
Ambient Temp. 5	10°C

Water Temp. A/Ambient Temp. 1	40°C
Water Temp. B/Ambient Temp. 2	37°C
Water Temp. C/Ambient Temp. 3	33°C
Water Temp. D/Ambient Temp. 4	29°C
Water Temp. E/Ambient Temp. 5	25°C

**H.2.** If no heating curve is desired:

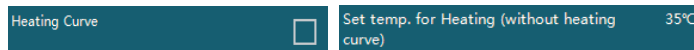

**C.** Configuring the set water cooling temperature (if applicable):



If cooling function is desired, ensure these sections are configured.

3. Locate and activate the buffer tank and appropriate pumps under

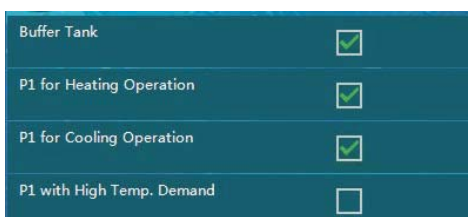

### 3. Assembly Configurations – Drawing 6

---

#### Software: Basic Settings (continued)

4. Double-check to ensure that the Domestic Hot Water option is enabled under

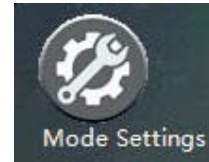

5. Configure the desired setpoint for water temperature (default set to 50°C):



### 3. Assembly Configurations – Drawing 7

Please ensure that the configuration matches the assembly drawing depicted on the right for a one temperature zone setup that includes domestic hot water; that also includes a component circuit capable of heating or cooling only, through the use of a two-way motorized valve.

*Note:* For the cooling-only or heating-only circuit, a motorized two-way valve can be connected to the unit, to cut the water supply during heating or cooling operation.

Refer to the next page for wiring and software operation instructions.

Name	Symbol	Name	Symbol
Temp. Sensor		Water pump	
Safety valve kit		Mixing valve	
Ball valve		Motorized valve	
Water filter		Expansion tank	
Air purging valve			

*Notice:* The Fan Coil Unit, Floor Heating System, and Radiator are placeholder distribution systems only and can be substituted by any other appropriate distribution systems.

*Note:* Dotted lines mean "able to be controlled by the Heat Pump".

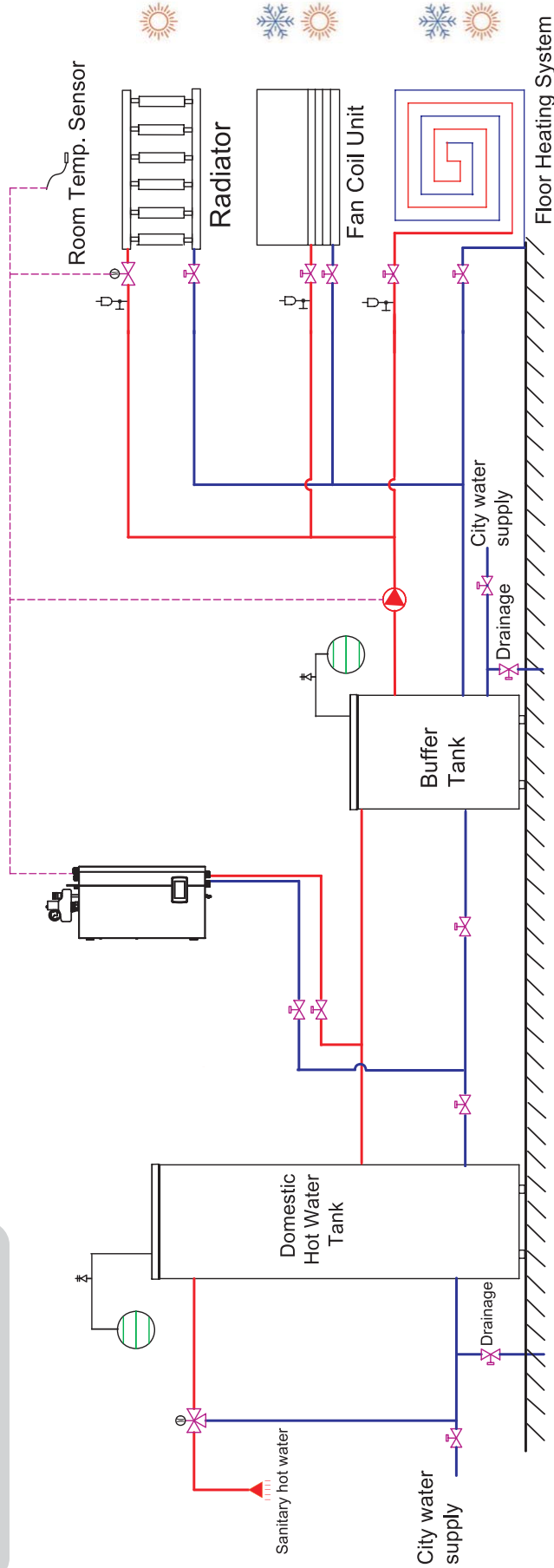

One Temperature Zone, with DHW, with a heating-only (or cooling-only) circuit, by usage of a motorized 2-way valve



# 3. Assembly Configurations – Drawing 7

## Assembly 7: Wiring Diagram

To achieve successful operation at a minimum, ensure the ports below are properly connected.

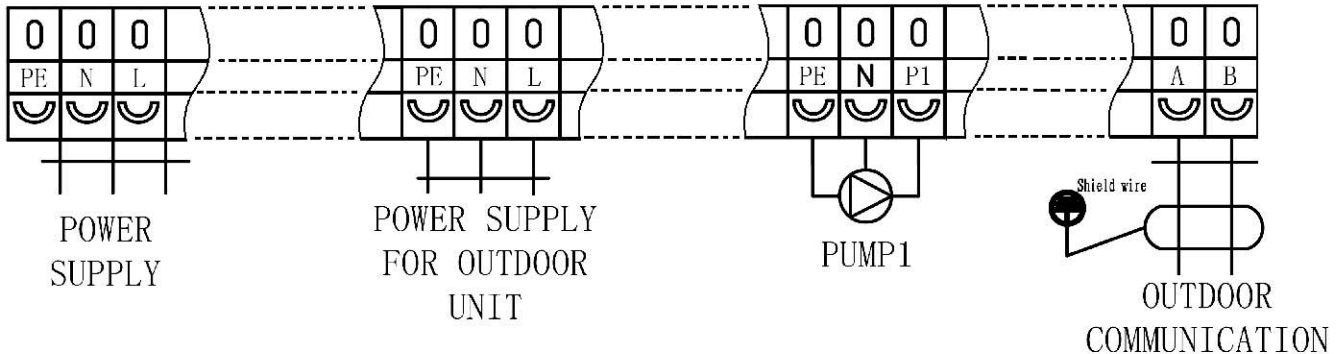

## Software: Basic Settings

1. Set the needed working modes of the unit via the menu

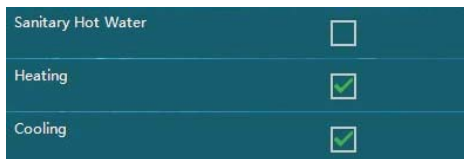

2. Temperature configuration options for Heating/Cooling circuit 1 are found under

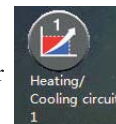

**H.** Configuring the set water heating temperatures:

**H.1.** Setting a heating curve:



Ambient Temp. 1	-25°C
Ambient Temp. 2	-15°C
Ambient Temp. 3	-5°C
Ambient Temp. 4	5°C
Ambient Temp. 5	10°C

Water Temp. A/Ambient Temp. 1	40°C
Water Temp. B/Ambient Temp. 2	37°C
Water Temp. C/Ambient Temp. 3	33°C
Water Temp. D/Ambient Temp. 4	29°C
Water Temp. E/Ambient Temp. 5	25°C

**H.2.** If no heating curve is desired:

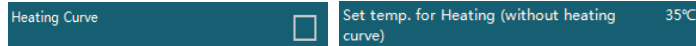

**C.** Configuring the set water cooling temperature (if applicable):



If cooling function is desired, ensure these sections are configured.

3. Locate and activate the buffer tank and appropriate pumps under

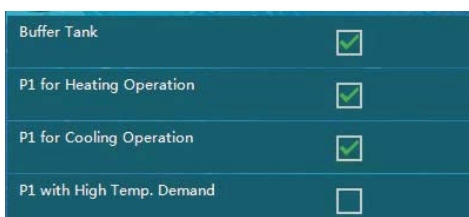

### 3. Assembly Configurations – Drawing 7

#### Software: Basic Settings (continued)

4. The location of the configuration for heating-only or cooling-only system is under

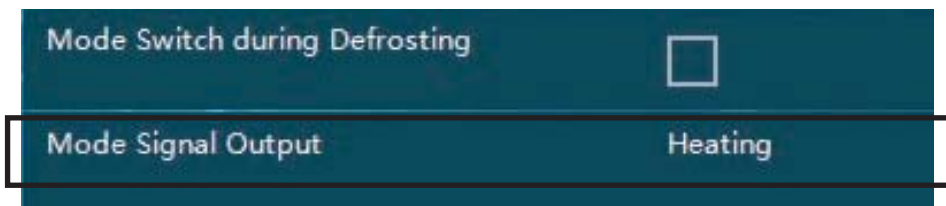
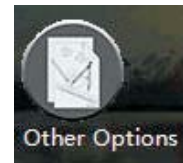

5. Double-check to ensure that the Domestic Hot Water option is enabled under

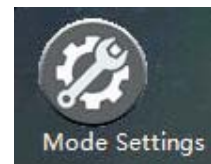

6. Configure the desired setpoint for water temperature (default set to 50°C):



### 3. Assembly Configurations – Drawing 8

Please ensure that the configuration matches the assembly drawing depicted on the right for a two temperature zone setup that includes domestic hot water.

*Note: Refer to the next page for wiring and software operation instructions.*

Name	Symbol	Name	Symbol
Temp. Sensor		Water pump	
Safety valve Kit		Mixing valve	
Ball valve		Motorized valve	
Water filter		Expansion tank	
Air purging valve			

*Note: Dotted lines mean "able to be controlled by the Heat Pump".*

*Notice: The Fan Coil Unit, Floor Heating System, and Radiator are placeholder distribution systems only and can be substituted by any other appropriate distribution systems.*

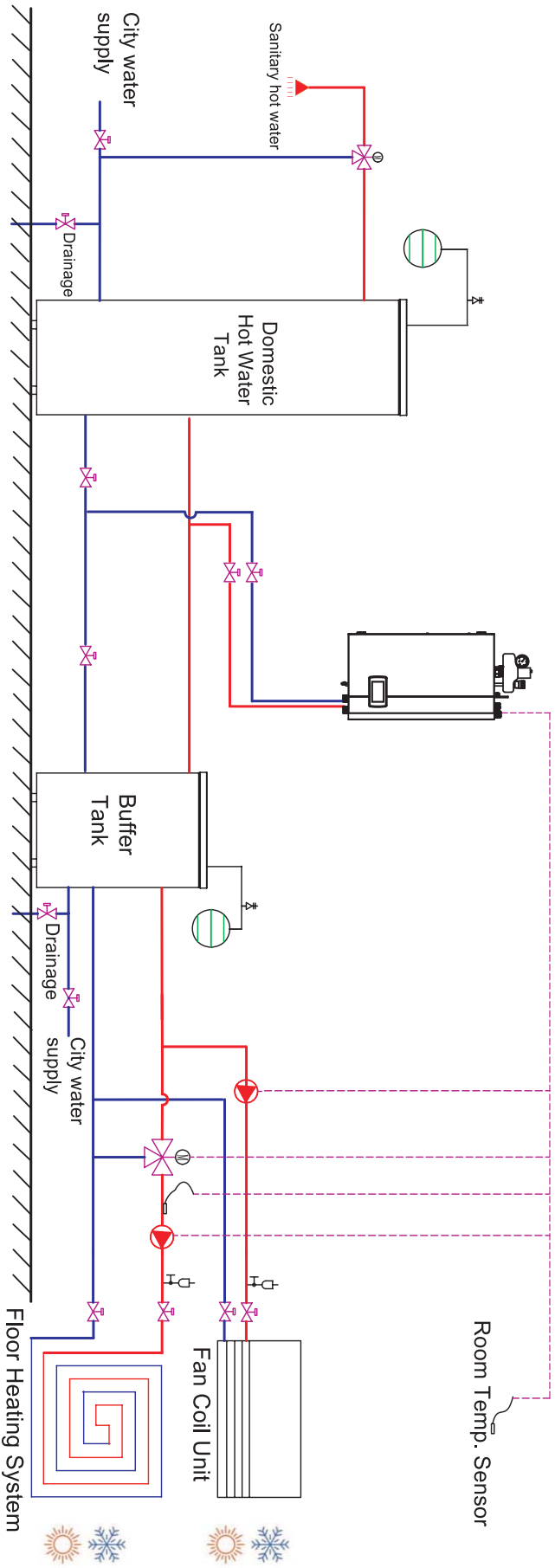

Two Temperature Zone, with DHW

# 3. Assembly Configurations – Drawing 8

## Assembly 8: Wiring Diagram

To achieve successful operation at a minimum, ensure the ports below are properly connected.

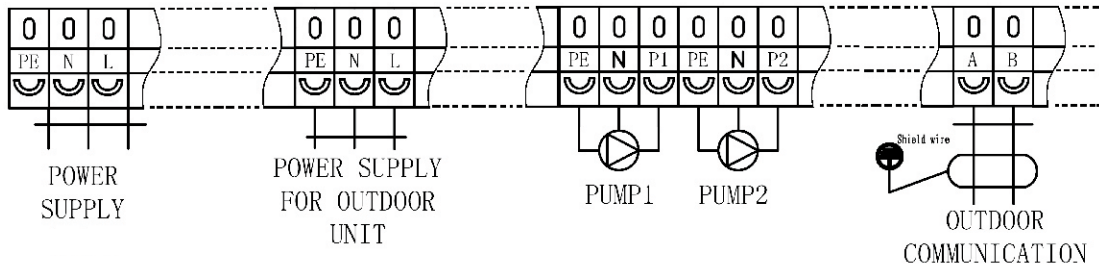

For connection for mixing valve 2, please refer to the appendix A (on page 78-79) of this manual for more information.

## Software: Basic Settings

1. Set the needed working modes of the unit via the menu

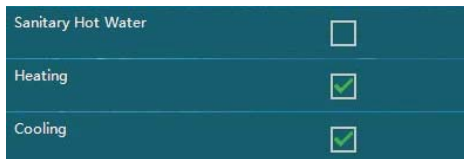
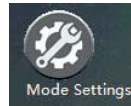

2. Temperature configuration options for Heating/Cooling circuit 1 are found under

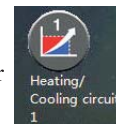

**H.** Configuring the set water heating temperatures:

**H.1.** Setting a heating curve:



Ambient Temp. 1	-25°C	Water Temp. A/Ambient Temp. 1	40°C
Ambient Temp. 2	-15°C	Water Temp. B/Ambient Temp. 2	37°C
Ambient Temp. 3	-5°C	Water Temp. C/Ambient Temp. 3	33°C
Ambient Temp. 4	5°C	Water Temp. D/Ambient Temp. 4	29°C
Ambient Temp. 5	10°C	Water Temp. E/Ambient Temp. 5	25°C

**H.2.** If no heating curve is desired:

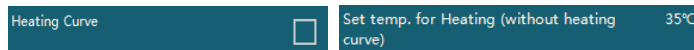

**C.** Configuring the set water cooling temperature (if applicable):

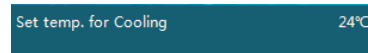

If cooling function is desired, ensure these sections are configured.

3. Locate and activate the buffer tank and appropriate pumps under

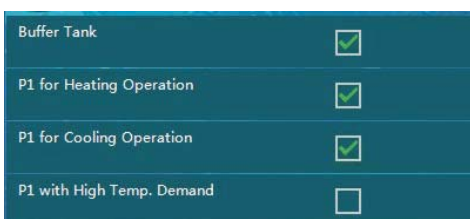
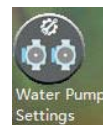

# 3. Assembly Configurations – Drawing 8

## Software: Basic Settings (continued)

3.(cont.) Configure the water pump to operate for heating or cooling:

P2 for Heating Operation

P2 for Cooling Operation



4. Temperature configuration options for Heating/Cooling circuit 2 are found under

H. configuring the set water heating temperatures:

H.1. Setting a heating curve:

Heating Curve

Water Temp. A/Ambient Temp. 1	40°C
Water Temp. B/Ambient Temp. 2	37°C
Water Temp. C/Ambient Temp. 3	33°C
Water Temp. D/Ambient Temp. 4	29°C
Water Temp. E/Ambient Temp. 5	25°C

H.2. If no heating curve is desired:

Heating Curve

Set Temp. for Heating (without heating curve) 35°C

Dependent on whether cooling is needed

C. Configuring the set water cooling temperature (if applicable):

Set temp. For Cooling 24°C

4.1. Activate the mixing valve to manage the second circuit:

Mixing Valve

*Note: This pair of settings will interpret "Heating/Cooling Circuit 2 as the low demand distribution system, requiring a lower set temperature for heating and higher set temperature for cooling.*

5. Double-check to ensure that the Domestic Hot Water option is enabled under

Sanitary Hot Water

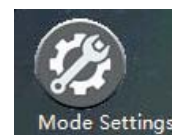

6. Configure the desired setpoint for water temperature (default set to 50°C):

Setpoint DHW 50°C

### 3. Assembly Configurations – Drawing 9

Please ensure that the configuration matches the assembly drawing depicted on the right for a two temperature zone setup that includes domestic hot water, also that includes a component circuit capable of heating or cooling only, through the use of a two-way motorized valve.

*Note: For the cooling-only or heating-only circuit, a motorized two-way valve can be connected to the unit, to cut the water supply during heating or cooling operation.*

*Refer to the next page for wiring and software operation instructions.*

Name	Symbol	Name	Symbol
Temp. Sensor		Water pump	
Safety valve Kit		Mixing valve	
Ball valve		Motorized valve	
Water filter		Expansion tank	
Air purging valve			

*Notice: The Fan Coil Unit, Floor Heating System, and Radiator are placeholder distribution systems only and can be substituted by any other appropriate distribution systems.*

*Note: Dotted lines mean "able to be controlled by the Heat Pump".*

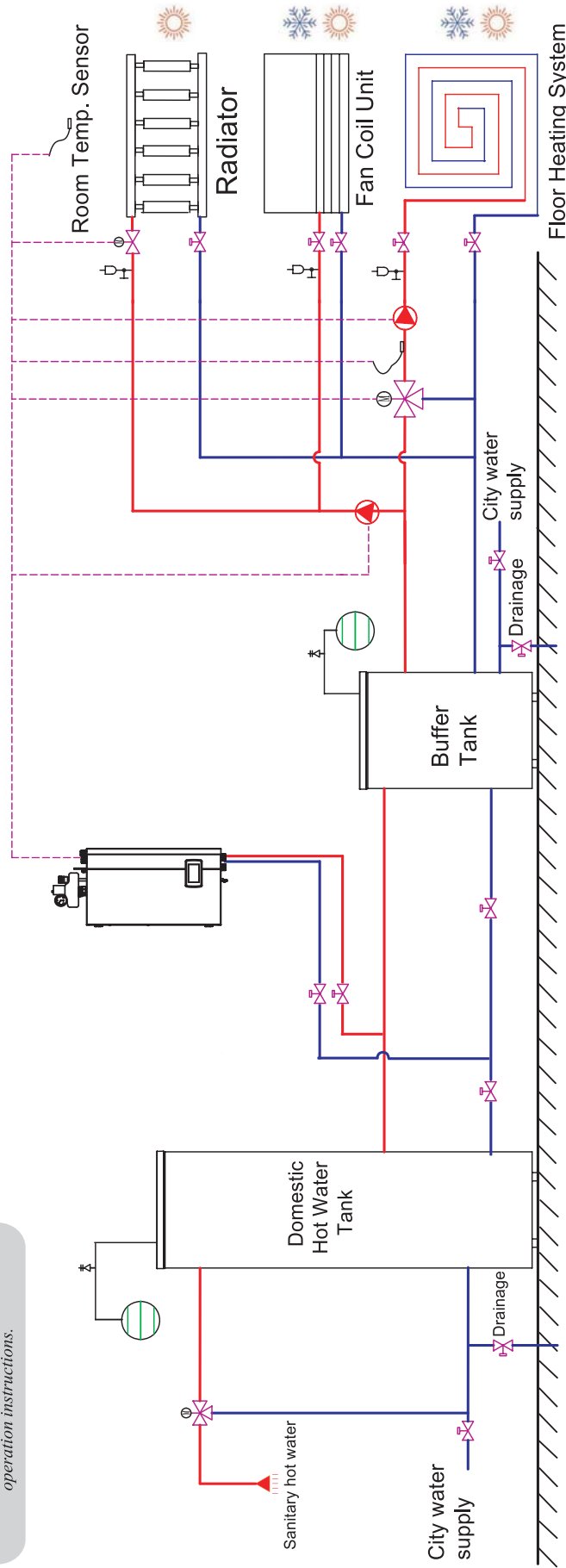

Two Temperature Zones , without DHW, with a heating-only (or cooling-only) circuit, by usage of a motorized 2-way valve

# 3. Assembly Configurations – Drawing 9

## Assembly 9: Wiring Diagram

To achieve successful operation at a minimum, ensure the ports below are properly connected.

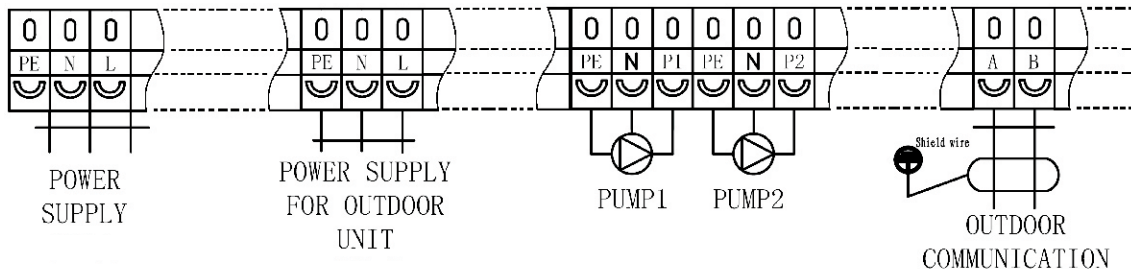

For connection for mixing valve 2, please refer to the appendix A (on page 78-79) of this manual for more information.

## Software: Basic Settings

1. Set the needed working modes of the unit via the menu

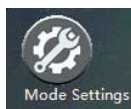

2. Temperature configuration options for Heating/Cooling circuit 1 are found under



H. Configuring the set water heating temperatures:

H.1. Setting a heating curve:



Ambient Temp. 1	-25°C	Water Temp. A/Ambient Temp. 1	40°C
Ambient Temp. 2	-15°C	Water Temp. B/Ambient Temp. 2	37°C
Ambient Temp. 3	-5°C	Water Temp. C/Ambient Temp. 3	33°C
Ambient Temp. 4	5°C	Water Temp. D/Ambient Temp. 4	29°C
Ambient Temp. 5	10°C	Water Temp. E/Ambient Temp. 5	25°C

H.2. If no heating curve is desired:

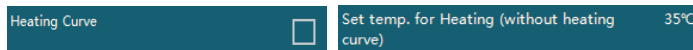

C. Configuring the set water cooling temperature (if applicable):

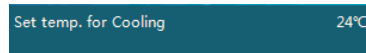

If cooling function is desired, ensure these sections are configured.

3. Locate and activate the buffer tank and appropriate pumps under

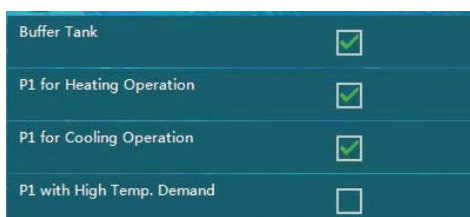
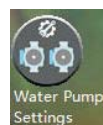

# 3. Assembly Configurations – Drawing 9

## Software: Basic Settings (continued)

3.(cont.) Configure the water pump to operate for heating or cooling:

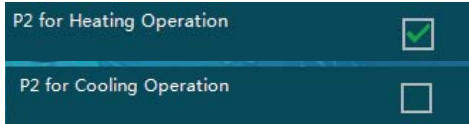

4. The location of the configuration for heating-only or cooling-only system is under

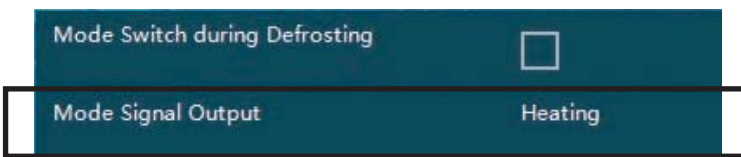
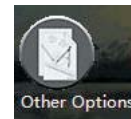

5. Temperature configuration options for Heating/Cooling circuit 2 are found under H. configuring the set water heating temperatures:

H.1. Setting a heating curve:



Water Temp. A/Ambient Temp. 1	40°C
Water Temp. B/Ambient Temp. 2	37°C
Water Temp. C/Ambient Temp. 3	33°C
Water Temp. D/Ambient Temp. 4	29°C
Water Temp. E/Ambient Temp. 5	25°C

H.2. If no heating curve is desired:



Set Temp. for Heating (without heating curve)	35°C
---	------

C. Configuring the set water cooling temperature (if applicable):



5.1. Activate the mixing valve to manage the second circuit:



*Note: This pair of settings will interpret “Heating/Cooling Circuit 2 as the low demand distribution system, requiring a lower set temperature for heating and higher set temperature for cooling.*

6. Double-check to ensure that the Domestic Hot Water option is enabled under

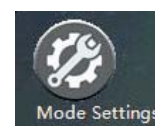

7. Configure the desired setpoint for water temperature (default set to 50°C):



Dependent on whether cooling is needed



# 3. Assembly Configurations – Drawing 10

Please ensure that the configuration matches the assembly drawing depicted on the right for a two temperature zone setup that includes domestic hot water, also that utilizes the secondary pump for a heating-only operation.

*Note: For the heating-only circuit, a motorized two-way valve can be connected to the unit, to cut the water supply during heating operation.*

*Refer to the next page for wiring and software operation instructions.*

Name	Symbol	Name	Symbol
Temp. Sensor		Water pump	
Safety valve Kit		Mixing valve	
Ball valve		Motorized valve	
Water filter		Expansion tank	
Air purging valve			

*Note: Dotted lines mean "able to be controlled by the Heat Pump".*

*Notice : The Fan Coil Unit, Floor Heating System, and Radiator are placeholder distribution systems only and can be substituted by any other appropriate distribution systems.*

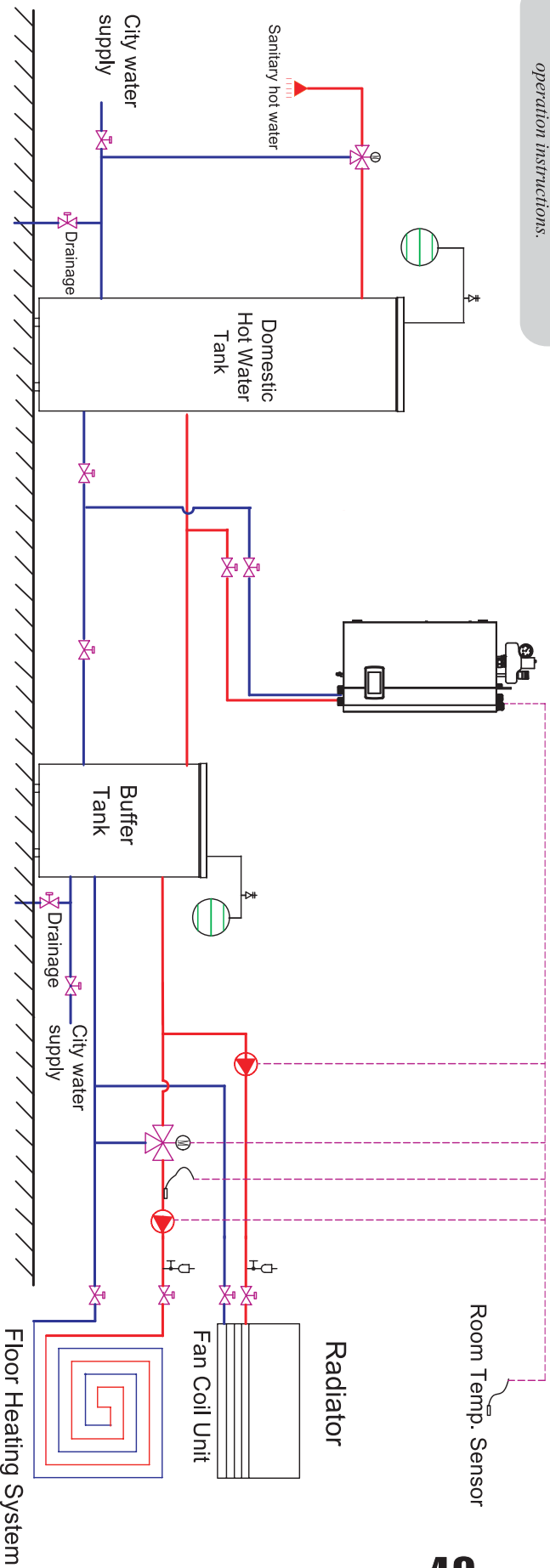

**Two Temperature Zones , without DHW, with a heating-only circuit, by setting the secondary pump to heating-only**

# 3. Assembly Configurations – Drawing 10

## Assembly 10: Wiring Diagram

To achieve successful operation at a minimum, ensure the ports below are properly connected.

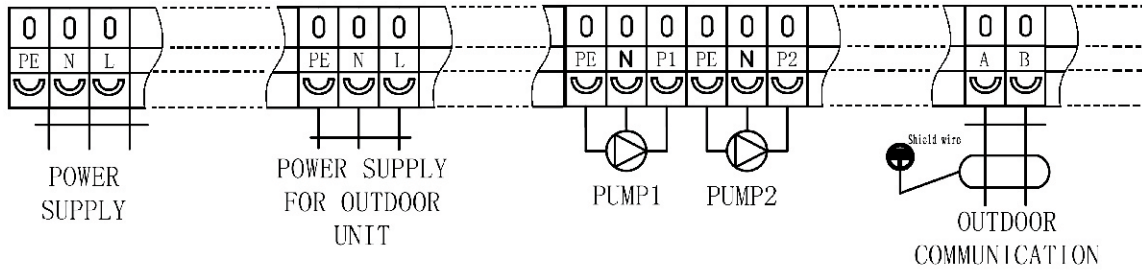

For connection for mixing valve 2, please refer to the appendix A (on page 78-79) of this manual for more information.

## Software: Basic Settings

1. Set the needed working modes of the unit via the menu

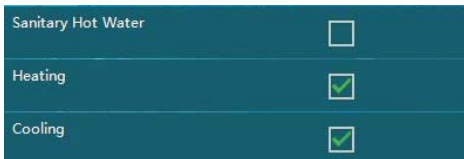

2. Temperature configuration options for Heating/Cooling circuit 1 are found under

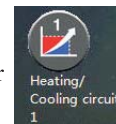

**H.** Configuring the set water heating temperatures:

**H.1.** Setting a heating curve:



Ambient Temp. 1	-25°C	Water Temp. A/Ambient Temp. 1	40°C
Ambient Temp. 2	-15°C	Water Temp. B/Ambient Temp. 2	37°C
Ambient Temp. 3	-5°C	Water Temp. C/Ambient Temp. 3	33°C
Ambient Temp. 4	5°C	Water Temp. D/Ambient Temp. 4	29°C
Ambient Temp. 5	10°C	Water Temp. E/Ambient Temp. 5	25°C

**H.2.** If no heating curve is desired:



**C.** Configuring the set water cooling temperature (if applicable):

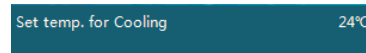

If cooling function is desired, ensure these sections are configured.

3. Locate and activate the buffer tank and appropriate pumps under

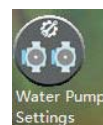

# 3. Assembly Configurations – Drawing 10

## Software: Basic Settings (continued)

3.(cont.) Configure the water pump to operate for heating or cooling:



4. Temperature configuration options for Heating/Cooling circuit 2 are found under

H. configuring the set water heating temperatures:

H.1. Setting a heating curve:



Water Temp. A/Ambient Temp. 1	40°C
Water Temp. B/Ambient Temp. 2	37°C
Water Temp. C/Ambient Temp. 3	33°C
Water Temp. D/Ambient Temp. 4	29°C
Water Temp. E/Ambient Temp. 5	25°C

H.2. If no heating curve is desired:

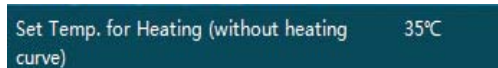

C. Configuring the set water cooling temperature (if applicable):



4.1. Activate the mixing valve to manage the second circuit:



*Note: This pair of settings will interpret “Heating/Cooling Circuit 2 as the low demand distribution system, requiring a lower set temperature for heating and higher set temperature for cooling.*

5. Double-check to ensure that the Domestic Hot Water option is enabled under

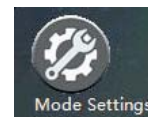

6. Configure the desired setpoint for water temperature (default set to 50°C):



# 4. Installation Walkthrough

## 4.1. Sanitary Hot Water Applications

If sanitary hot water is needed, a 3-way diverting valve should be included. It is recommended to set up your sanitary hot water system identically to one of the configurations shown below and on the following pages.

### 4.1.1. Configuration 1

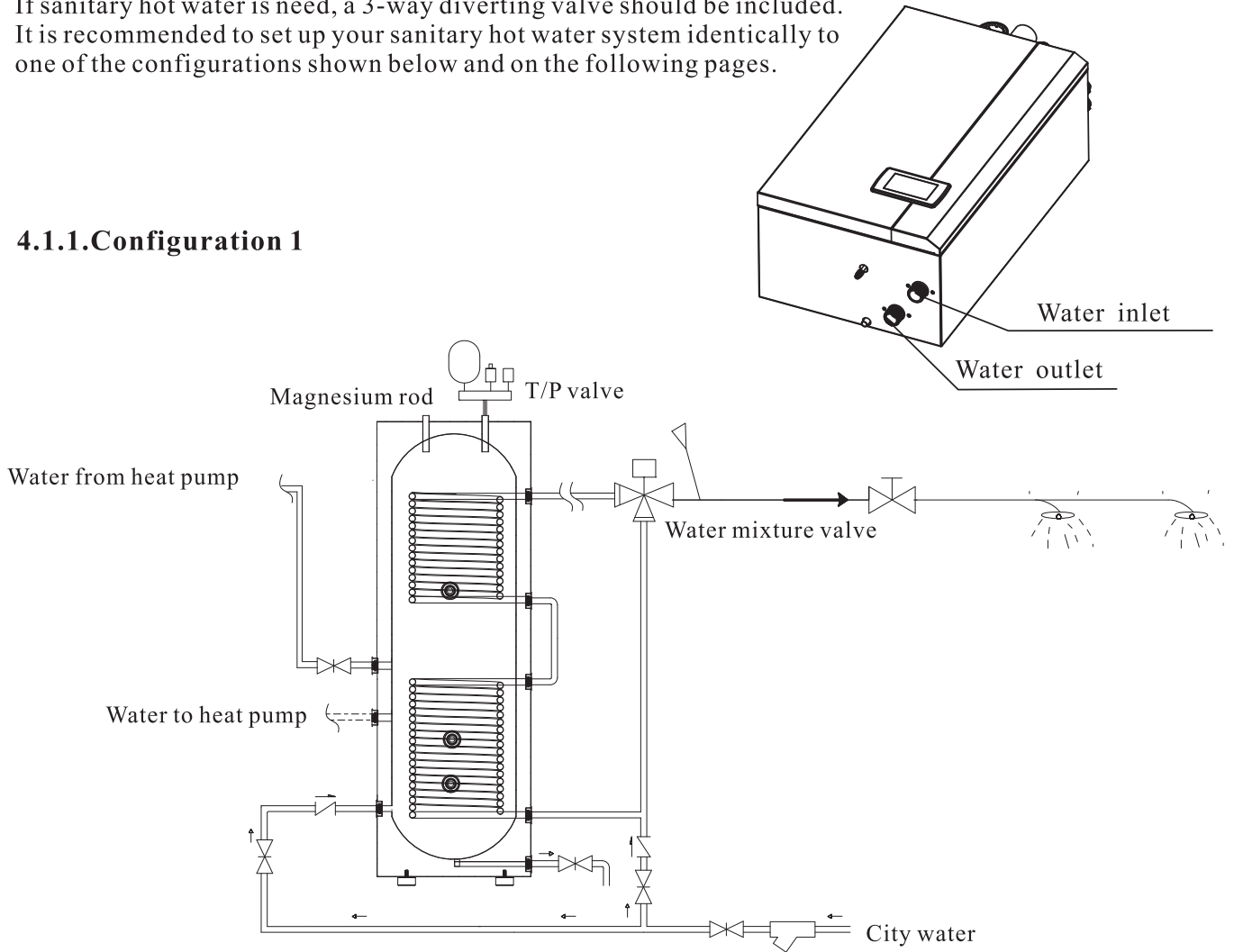

In this configuration, hot water circulating through the heat pump circuit floods the tank. This submerges the coils, which run the shower water circuit, resulting in a heat exchange interaction. A mixing valve ensures that temperatures do not exceed 60°C

The primary advantages of this application include:

- Sanitization is not necessary, since the sanitary hot water is heated by going through the coils.
- Direct connection between heat pump and tank, ensuring effective water flow rates for it.
- Energy savings from not requiring sanitization.

A disadvantage of this configuration is a decreased volume of sanitary hot water available when compared with other configurations, due to the smaller diameter of the transfer coils.

## 4. Installation Walkthrough

### 4.1. Sanitary Hot Water Configurations

#### 4.1.2. Configuration 2

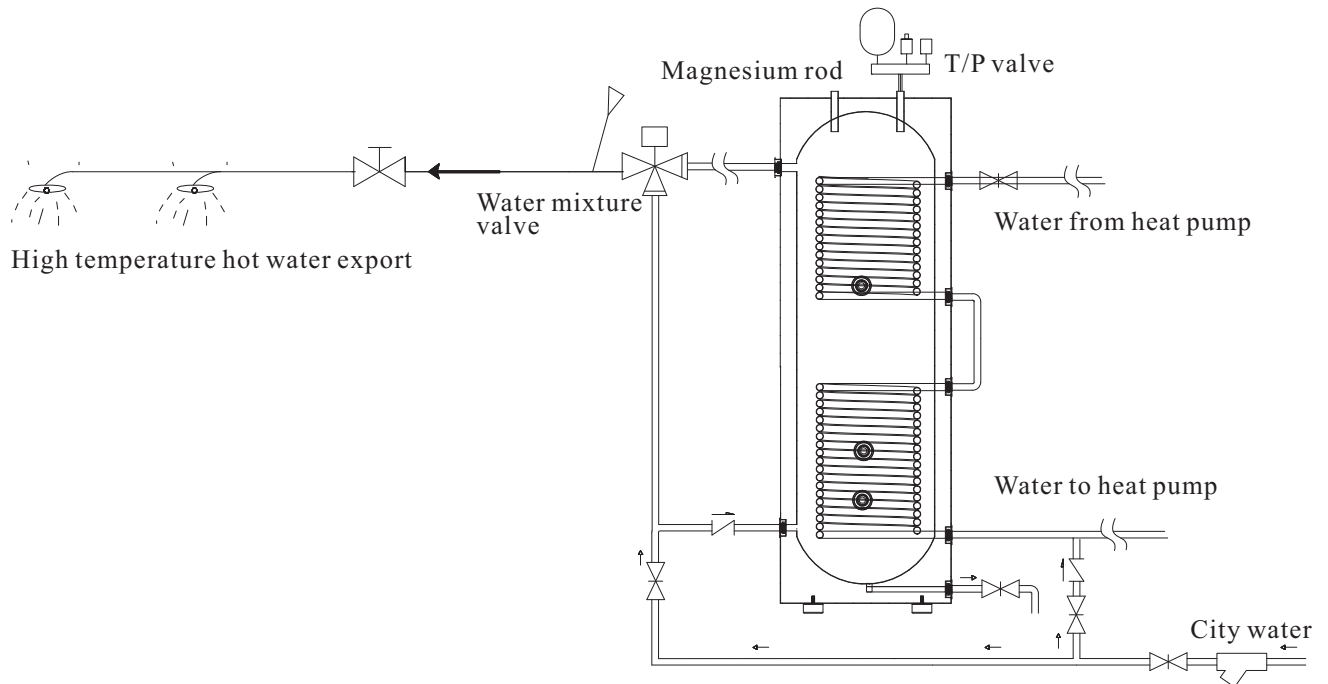

In this configuration, hot water from the heat pump circuit runs through the coils in the tank. Sanitary water fills the tank and is heated by the coils before exiting the tank towards the shower head. This configuration also does not require sanitization.

The primary advantage to this configuration is that it can supply a greater volume of sanitary hot water.

Disadvantages include:

- The coil may create enough resistance to water flow that a secondary heat pump could be needed, in order to ensure that a proper flow rate, efficiency, and proper operation are maintained.
- The capacity of the coils will need to be greater than or equal to the maximum output of the unit. (Max. heat pump output occurs at 7°C Air/45°C Water)

This configuration is optimal for a heat pump that does not exceed 14kW.

# 4. Installation Walkthrough

## 4.1. Sanitary Hot Water Configurations

### 4.1.3. Configuration 3

A water-to-water plate heat exchanger can be substituted for the coil inside water tank, as shown below:

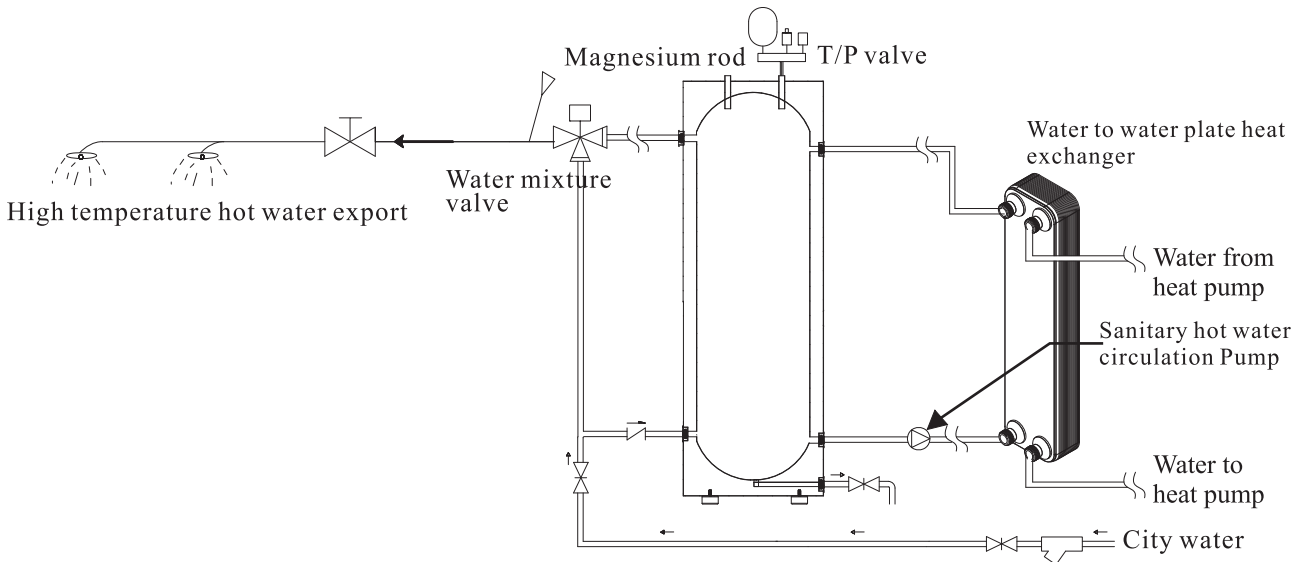

Note: The heat pump unit can control the sanitary hot water circulation pump by connecting it to port "P3".

This configuration will ensure a sufficient volume, as well as flow rate, of hot sanitary water, at the additional cost of adding the plate heat exchanger.

Whichever application is chosen, it is recommended to install a manual mixture valve between the city water inlet and hot water outlet. This will maximize utilization of hot water from the tank while also preventing scalding shower water temperatures.

Also, if the tank permits, it is optimal to utilize a 4-way mixture valve, as depicted in the picture below. This will promote more even and steady distribution of hot water from the tank.

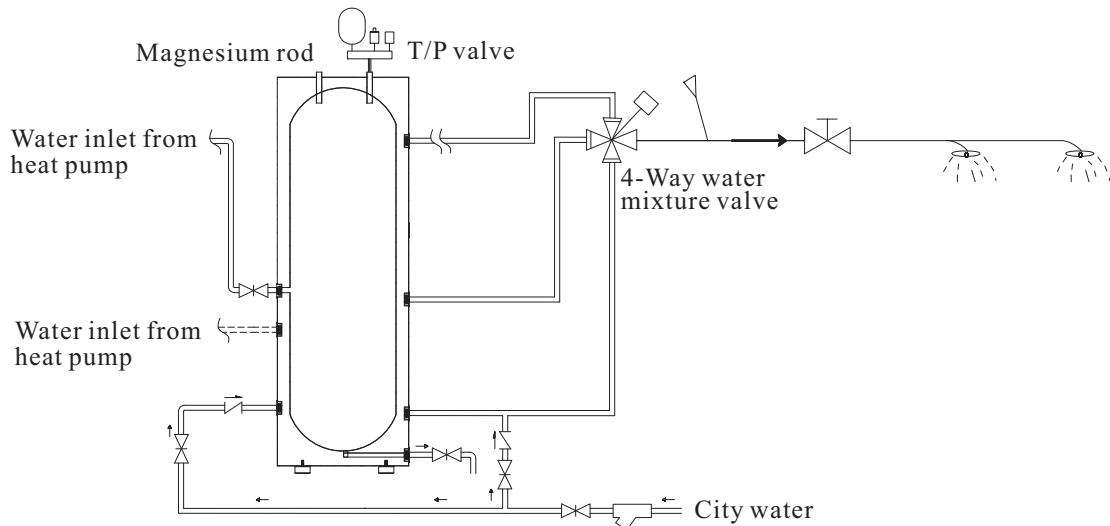

## 4. Installation Walkthrough

---

### 4.1. Sanitary Hot Water Configurations

---

#### 4.1.4. Note about the Heating/Cooling Distribution System

Users are heavily recommended to install a buffer tank into the chosen configuration, especially when the method of hot water distribution is below 20L/W of water volume.

The buffer tank should be installed between the heat pump and the distribution system, in order to:

- Ensure the heat pump unit provides a stable and sufficient water flow rate.
- Minimize fluctuation of the system's heating/cooling load by storing unused heat.
- Increase capacity of water volume distribution, which helps ensure proper heat pump operation.

If the method of hot water distribution is capable of dispersing a large enough flow rate, a buffer tank can be excluded from installation into the configuration. If so, please move the cooling/heating temperature sensor (TC, #10 on page 1) to the water return pipe, so that fluctuations of water temperature due to compressor speed changes are minimized.

# 4. Installation Walkthrough

## 4.2. Heating and Cooling Circuits

This heat pump unit is capable of controlling two completely different heating and cooling circuits, as shown in the following images.

Configuring the temperatures for circuits 1 and 2 can be done via the “Heating and Cooling Circuit” menus.

If only one circuit is desired, then “Heating and Cooling Circuit 2” can be set to OFF.

### 4.2.1. Heating & Cooling Circuits

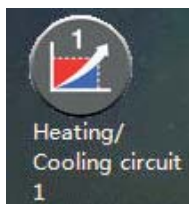

Heating/Cooling Stops Based on Water $\Delta T$	2°C
Heating/Cooling Restarts Based on Water $\Delta T$	2°C
$\Delta T$ Compressor Speed-reduction	2°C
Set temp. for Cooling	24°C
Heating Curve	<input checked="" type="checkbox"/>



Heatingcooling Circuit 2	<input type="checkbox"/>
Set temp. For Cooling	24°C
Set Temp. for Heating (without heating curve)	35°C
Mixing Valve	<input type="checkbox"/>
Heating Curve	<input checked="" type="checkbox"/>

The basic understanding of these settings is found under your the software section of your particular assembly walkthrough in Chapter 3. A more detailed explanation can be located in the user’s manual.



# 4. Installation Walkthrough

## 4.2. Heating and Cooling Circuits

### 4.2.2. Mixing Valves MV1 and MV2

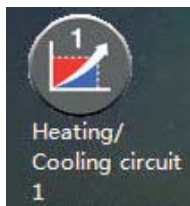

If the system water temperature may be higher (or lower) than the temperatures needed for circuit 1 (or circuit 2) in a heating or cooling operation, then a mixing valve can be added to the circuit, and connected to the MV1 (or MV2) port on the indoor unit.

The unit will control the mixing valve, continuously mix the supply, and return the water of the circuit to have its temperature read via the TV1 (or TV2) until the value set under the above menus is achieved.

TV1 and/or TV2 should be activated on the installer's level via the "Heating and Cooling Circuit" menu.

Note: A mixing valve is needed, if:

- The system has two circuits that require different water temperatures. The heat pump will have to take the higher/lower (depending on whether heating/cooling) settings of the two circuits as the set temperature for the heat pump. The mixing valve ensures correct water temperature circulation in this instance.
- The system has other heating sources inside that are not controlled by the heat pump. In this case, the actual water temperature may exceed the set temperature.

## 4. Installation Walkthrough

### 4.2. Heating and Cooling Circuits

#### 4.2.3. Circulation Pump Control



Buffer Tank	<input type="checkbox"/>
P1 for Heating Operation	<input type="checkbox"/>
P1 for Cooling Operation	<input type="checkbox"/>
P1 with High Temp. Demand	<input type="checkbox"/>
P2 for Heating Operation	<input type="checkbox"/>
P2 for Cooling Operation	<input type="checkbox"/>
P2 with High Temp. Demand	<input type="checkbox"/>

*Note: P1 is circulation pump 1, P2 is pump 2*

- “Buffer Tank” should be checked if one is installed between the heat pump and distribution system.
- “P1/P2 for Heating/Cooling Operation” sets that circuit’s pump to work for heating or cooling.

If “Buffer Tank” is NOT checkmarked, both P1 and P2 will only work when the compressor is working in the same mode that the pump is set to. So, if P1 is set to “P1 for Heating Operation”, P1 will activate ONLY when the compressor is working in heating mode. If P1 is checkmarked for both “Heating” and “Cooling” operations, then P1 will be ON when the compressor is working in both heating and cooling modes. The pump stops when switched to DHW mode, or after the set temperature is reached.

If “Buffer Tank” IS checkmarked, both P1 and P2 will work as long as there is demand from the distribution system, as per the pump setting. The following must also be fulfilled:

- Actual temperature in the buffer tank (detected via TC) is equal or above 20°C (in heating)
- Actual temperature in the buffer tank (detected via TC) is equal or below 23°C (in cooling)

Even if the unit is working in DHW mode, or the set temperature is reached, the circulation pump will start to work as long as there are heating/cooling demands, and TC is fulfilled as per the above.

- “P1/P2 with High Temp. Demand” sets P1/P2 to automatically stop if the signal for “high demand” is off. For more information regarding this setting, please refer to part D on page 62.

**NOTE:** It is very important to place the temperature sensor (TR) in a central location with good circulation, with no hot or cold equipment nearby, in a column or interior wall, or somewhere similar.

## 4. Installation Walkthrough

---

### 4.3. Indoor Unit Installation

---

#### 4.3.1. Choosing an installation location

- 1) The indoor unit should be installed indoors, mounted on a wall, and have the water outlet aimed downwards.
- 2) The indoor unit must operate in a dry, well-ventilated location.
- 3) There should be no volatile, corrosive, or flammable liquids or gases nearby.
- 4) Ideally, the unit should be as close as possible to the water supply system.
- 5) Try and leave enough space in the area around the unit to simplify future maintenance.

The minimum dimensions of surrounding gaps suitable for the unit to operate correctly is as follows:

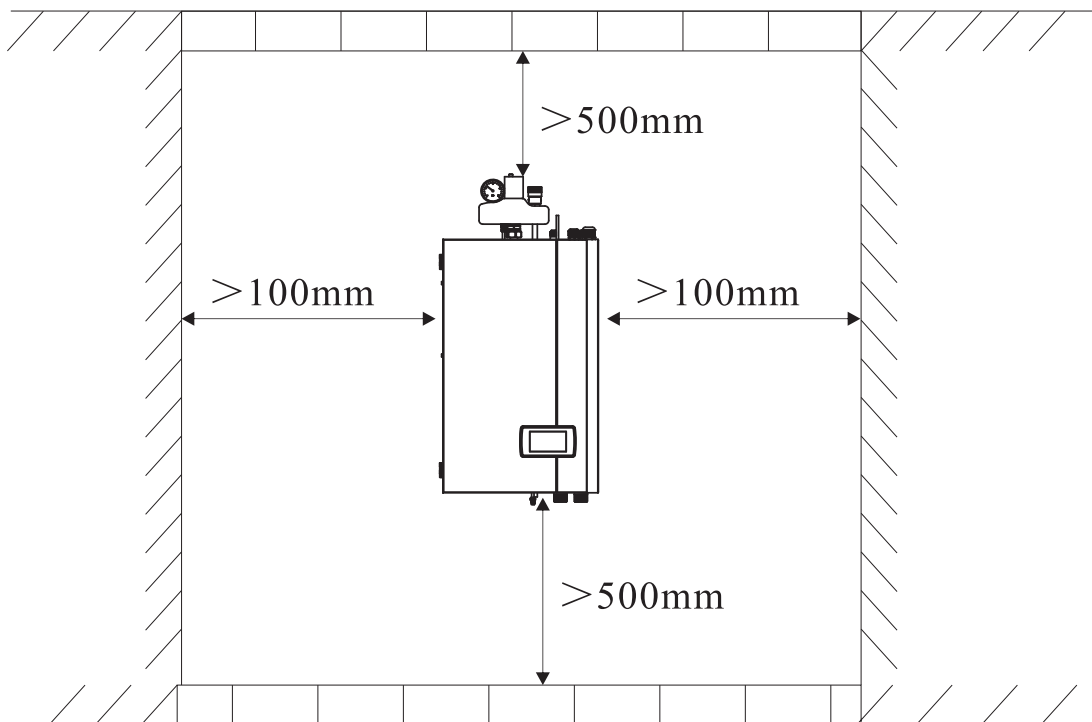

# 4. Installation Walkthrough

## 4.3. Indoor Unit Installation

### 4.3.2. Installation Process

Choose a very firm wall for installation. If it's a wooden wall, use self-tapping screws instead of expansion bolts. Hang the mounting board onto the wooden wall directly, without drilling holes. Ensure the wooden wall is sufficiently firm. Walls that are too thin, brittle, or humid are not adequate for installation.

- 1) Take out the expansion bolts and mounting board accessory. Place the mounting board on the wall horizontally. Mark the bolting location onto the wall.

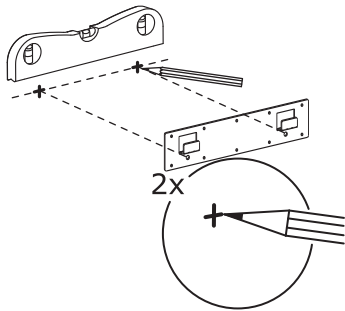

- 2) Drill holes with the proper diameter for the bolts to catch through.

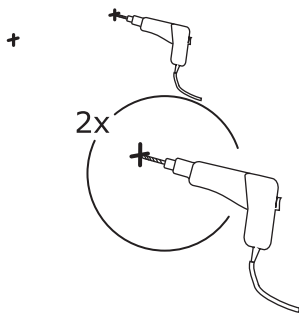

- 3) Unscrew the nuts from the expansion bolts.

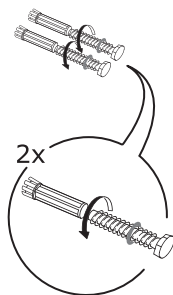

- 4) Loosely fix the mounting board onto the expansion bolts. Do not tighten yet.

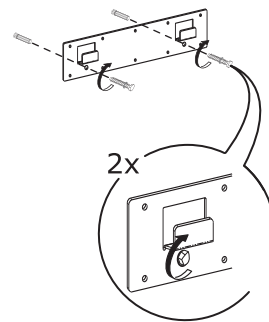

- 5) Using a hammer, tap the expansion bolts into the drilled holes. Fasten the nuts with a wrench to fix the mounting board to the wall.

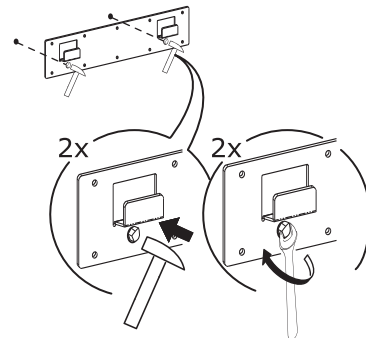

- 6) Hang the indoor unit onto the mounting board, making sure it is stable and placed well. The installation is then complete.



## 4. Installation Walkthrough

### 4.4. Outdoor Unit Installation

#### 4.4.1. Choosing an installation location

- 1) The outdoor unit can be installed in an open safe, corridor, balcony, roof, or hung onto the wall.
- 2) Install in a dry, open airspace. Humidity can cause corrosions or short-circuiting to the electronics.
- 3) There should be no volatile, corrosive, or flammable liquids or gases nearby.
- 4) Do not place the unit nearby to bedrooms and living rooms. There will be noise when it is running.
- 5) In harsh climates of snow or sub-zero temperatures, ensure the unit is raised 50cm above ground.
- 6) It is recommended to install an awning above the unit, to prevent snow from clogging open parts.
- 7) Ensure there is proper drainage around the unit. Tilt the unit by 1 cm/m for rain water evacuation.
- 8) Do not install the unit close to kitchen exhaust ports. It is difficult to clean oil from smoke exhaust.
- 9) The location of installation must provide sufficient space around the unit. The minimum dimensions of surrounding gaps suitable for the unit to operate correctly is as follows:

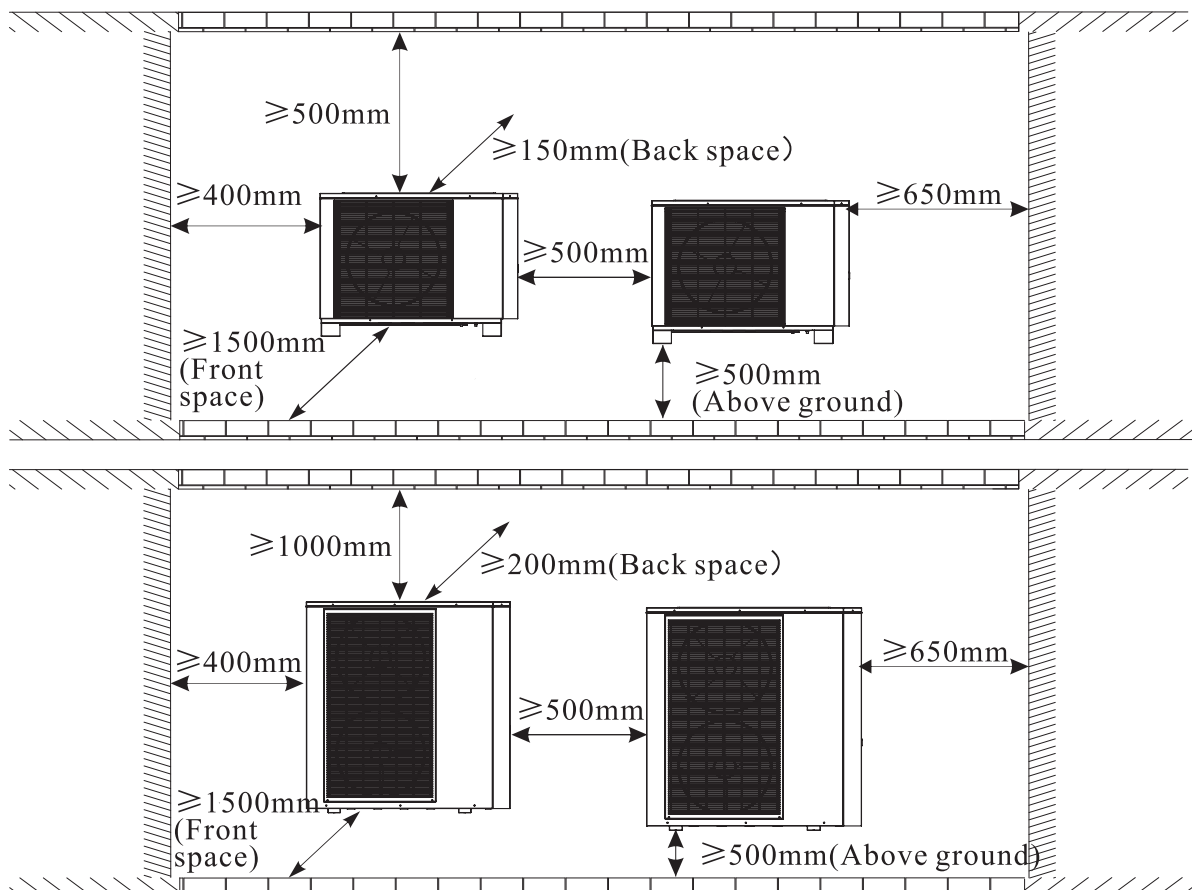

# 4. Installation Walkthrough

## 4.4. Outdoor Unit Installation

### 4.4.2. Installation Process

For the installation, users can either use the dedicated mounting bracket provided by the supplier, or prepare a suitable bracket that meets the following requirements.

- 1) The unit must be supported by either flat concrete blocks, or a dedicated mounting bracket. The bracket should be able to support at least 5x the unit's weight.
- 2) After the bracket is fixed, ensure each of the nuts are fully tightened.
- 3) Users should double check to make sure the unit's installation is sufficiently sturdy.
- 4) The bracket material can be stainless or galvanized steel, aluminum, or other proper substitutes.
- 5) The user can opt to use two concrete blocks, or a raised concrete platform, instead of a dedicated mounting bracket. Ensure that the unit is securely fastened after installation.
- 6) Use the outdoor unit's dimensions when choosing a suitable wall bracket.

The platform must be at least 500 mm above ground.

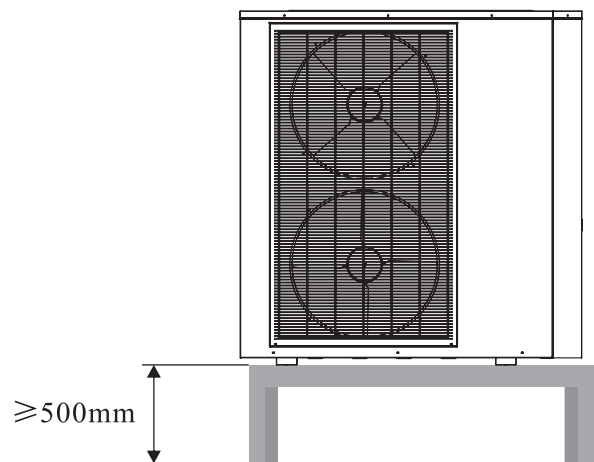

Holes for piping kits should be raised at least 8°  
This ensures rain water/condensate does not flow back indoors.

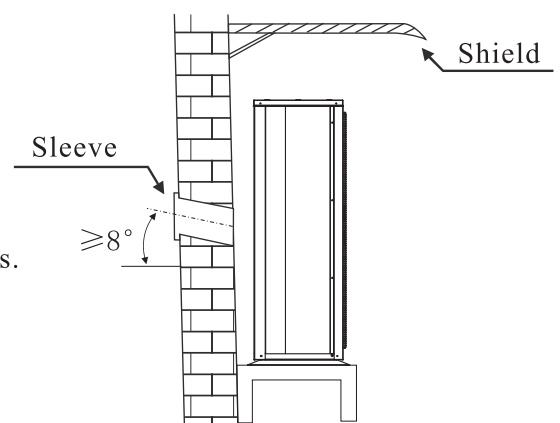

## 4. Installation Walkthrough

---

### 4.5. Wiring

---

#### 4.5.1. Explanation of Terminal Block 1

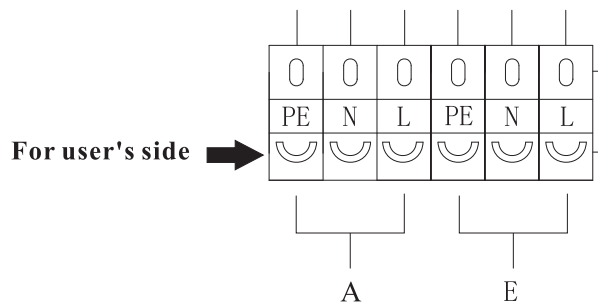

#### **A: Unit power supply**

This should be connected directly to the city power supply.

For all units, ensure that a cable of sufficient gauge is used. (found on nameplate)

#### **E: Outdoor unit power supply**

If the outdoor unit draws power from the indoor unit, this terminal should be connected through cable between the appropriate ports (see Appendix for wiring diagrams).

## 4. Installation Walkthrough

---

### 4.5. Wiring

---

#### 4.5.2. Explanation of Terminal Block 2

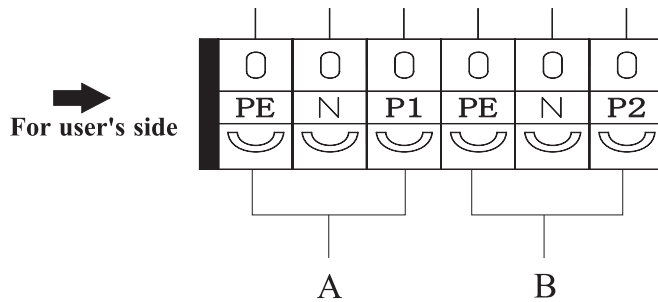

#### A, B: Water Pump

A-Pump 1: Pump for Heating & Cooling Circuit 1,  
B-Pump 2: Pump for Heating & Cooling Circuit 2,

If there is an external water pump in heating, cooling and hot water system, it can be connected to these ports, to be under the control of heat pump,



## 4. Installation Walkthrough

### 4.5. Wiring

#### 4.5.3. Explanation of Terminal Block 3

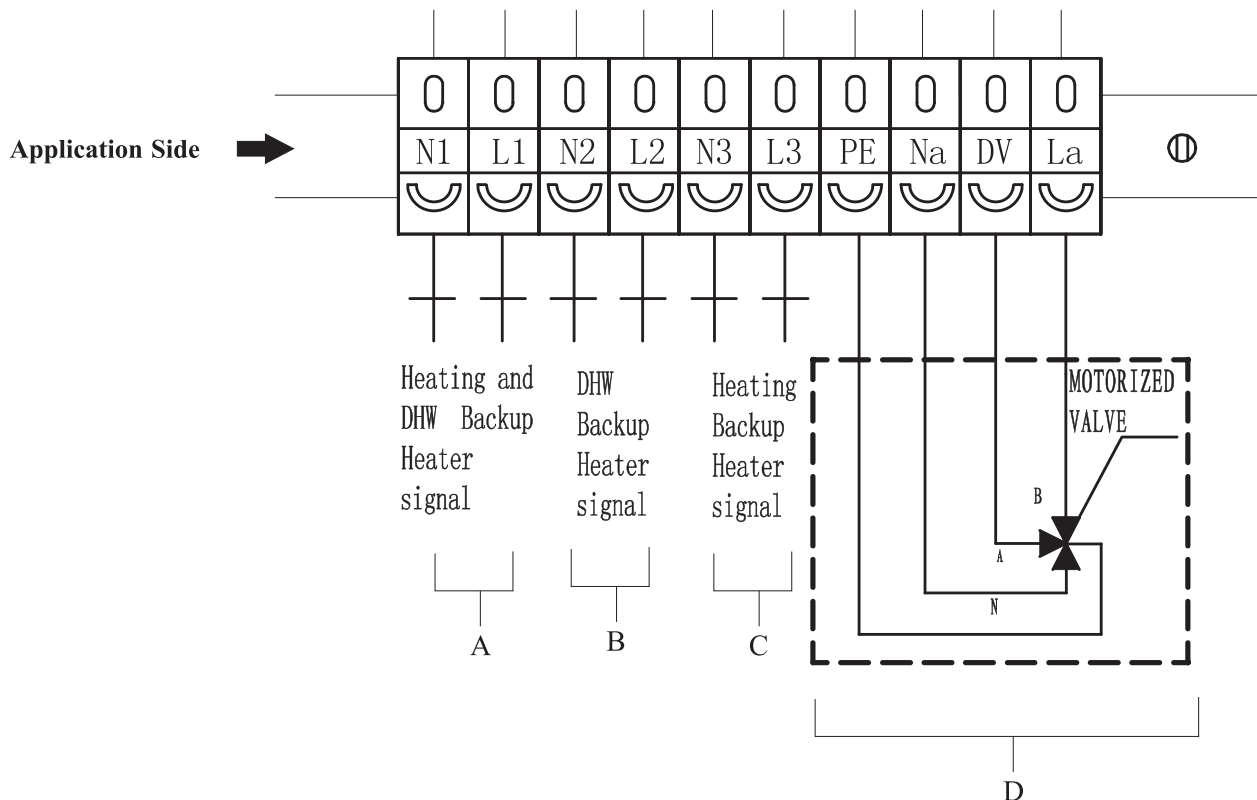

- A:** Signal output to Auxiliary Heater (AH), which will be used as auxiliary heating source for both heating and DHW operation.
- B:** Signal output to Hot Water Tank Backup Heater (HWTBH), which will be used as backup heating source for DHW operation only.
- C:** Signal output to Heating Backup Heater (hbh), which will be used as backup heating source for Heating operation only.
- D:** 3-way motorized valve diverting the water.

## 4. Installation Walkthrough

### 4.5. Wiring

#### 4.5.4. Explanation of Terminal Block 4

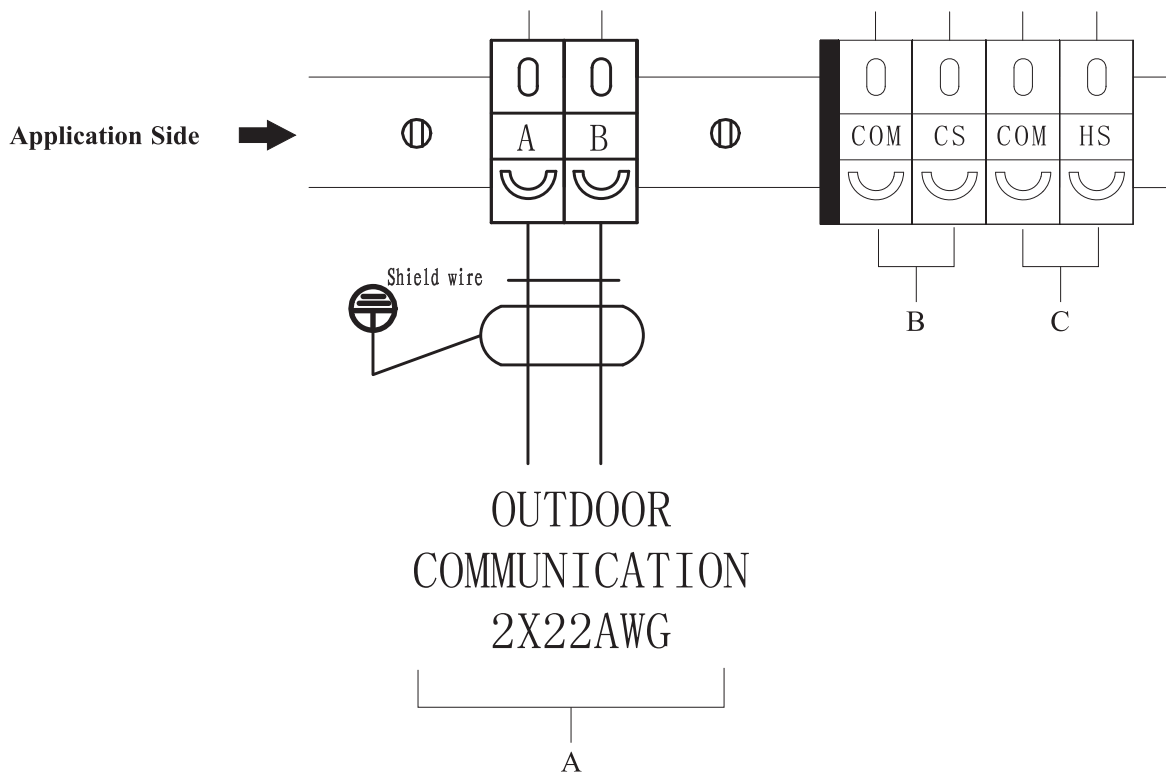

**A:** Signal cable between indoor and outdoor unit.

**B, C: Cooling and Heating Mode Switchovers**

This unit is capable of switching between heating and cooling automatically, according to the ambient temperature, or external signal input. Please refer to the user's manual for more detailed explanations on ambient temperature setting. For external signal input, the external signal should be connected to "Cool Mode Switch" for cooling operation, and "Heat Mode Switch" for heating operation.

## 4. Installation Walkthrough

### 4.5. Wiring

#### 4.5.5. Wiring Process Preliminary Precautions

- Please ensure that a suitable circuit breaker is used for the heat pump.
- The power supply to the heat pump unit must be grounded.
- Wiring should be done by a licensed professional, and comply with industry regulations.
- The unit should be completely powered off before any wiring is done.
- Cables should be properly fastened into place, to prevent loosening from occurring.
- No cable should be fastened to another.
- The power supply should be compliant to all standards located in the rating label.
- The power supply, necessary cables, and sockets should fully meet the input power requirements of the unit.

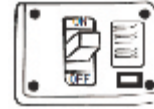

#### Installation sketch

NPH6-V7-S

NPH9-V7-S

NPH11-V7-S

NPH13-V7-S

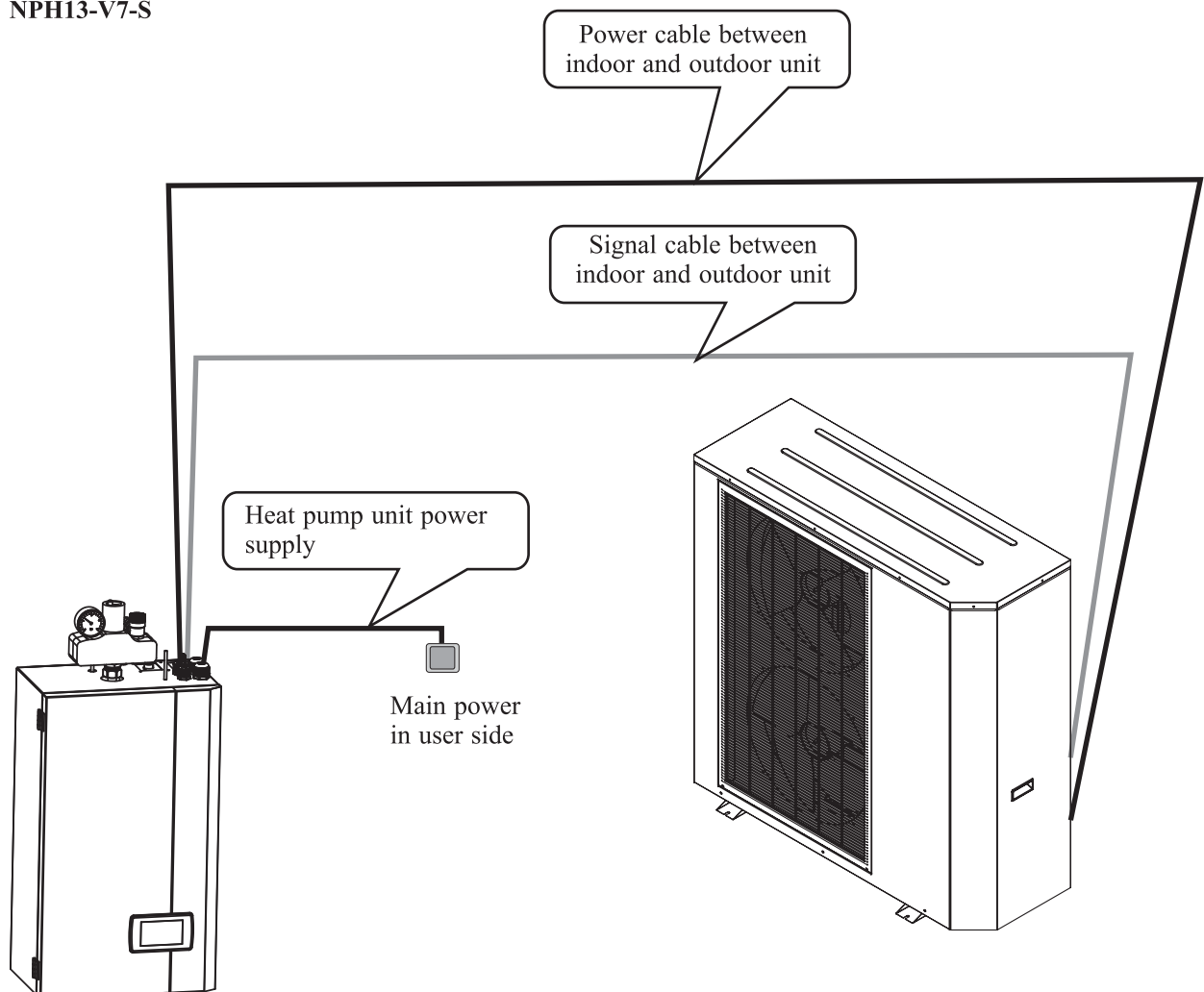

# 4. Installation Walkthrough

## 4.5. Wiring

### 4.5.5. Wiring Process

1) Open the indoor unit's front panel and remove the electrical box cover.

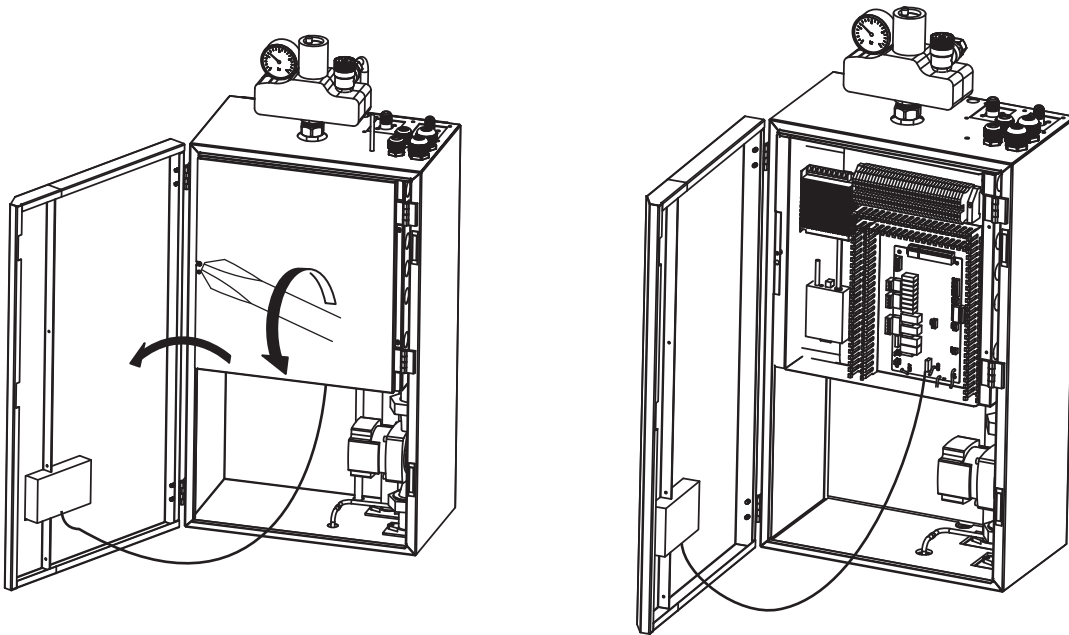

2) Acquire one (or two) power cable(s) of suitable length that is compliant to all local safety regulations.

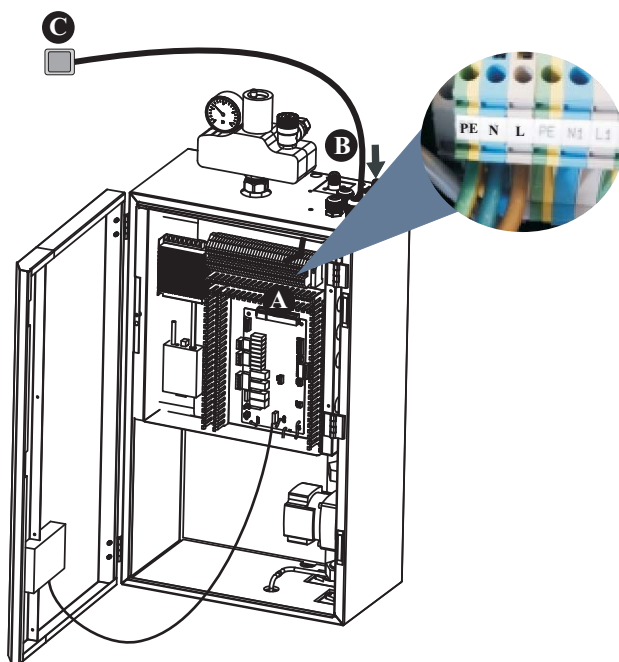

A. Insert one end of this cable through the cable gland on the bottom of the indoor unit, and connect it with the heat pump power supply terminals (PE, N, L).

B. Fasten the cable gland to ensure the cable won't loosen.

C. Connect the other end of the cable to the city power supply.

## 4. Installation Walkthrough

### 4.5. Wiring

3) Connect the auxiliary heater power cable:

Acquire a power cable of suitable length that is compliant to all local safety regulations.

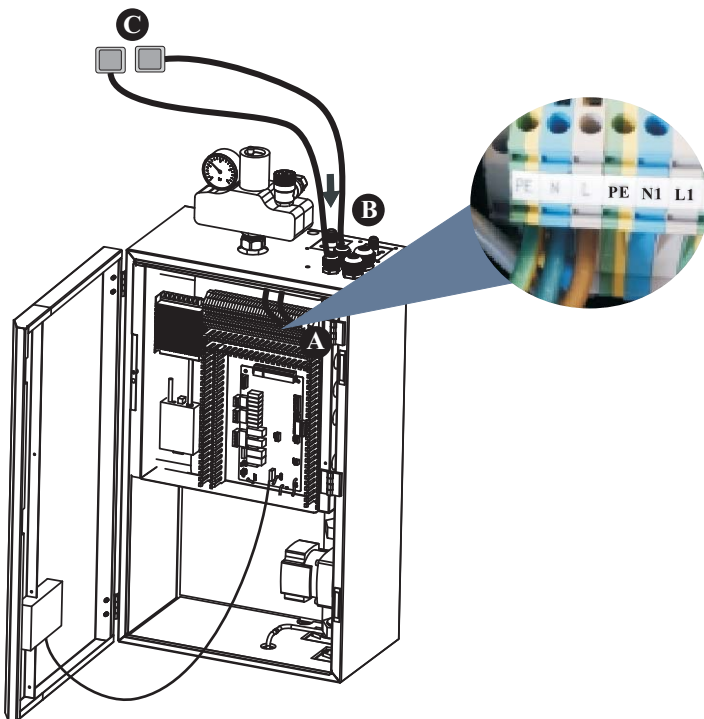

A. Insert one end of this cable through the cable gland on the bottom of the indoor unit, and connect it with the AH power supply terminals (PE, N1, L1)

B. Fasten the cable gland to ensure the cable won't loosen.

C. Connect the other end of the cable to the city power supply.

# 4. Installation Walkthrough

## 4.5. Wiring

- 4) Connect the signal cable between the indoor and outdoor unit:  
Retrieve the signal cable from the accessories bag.

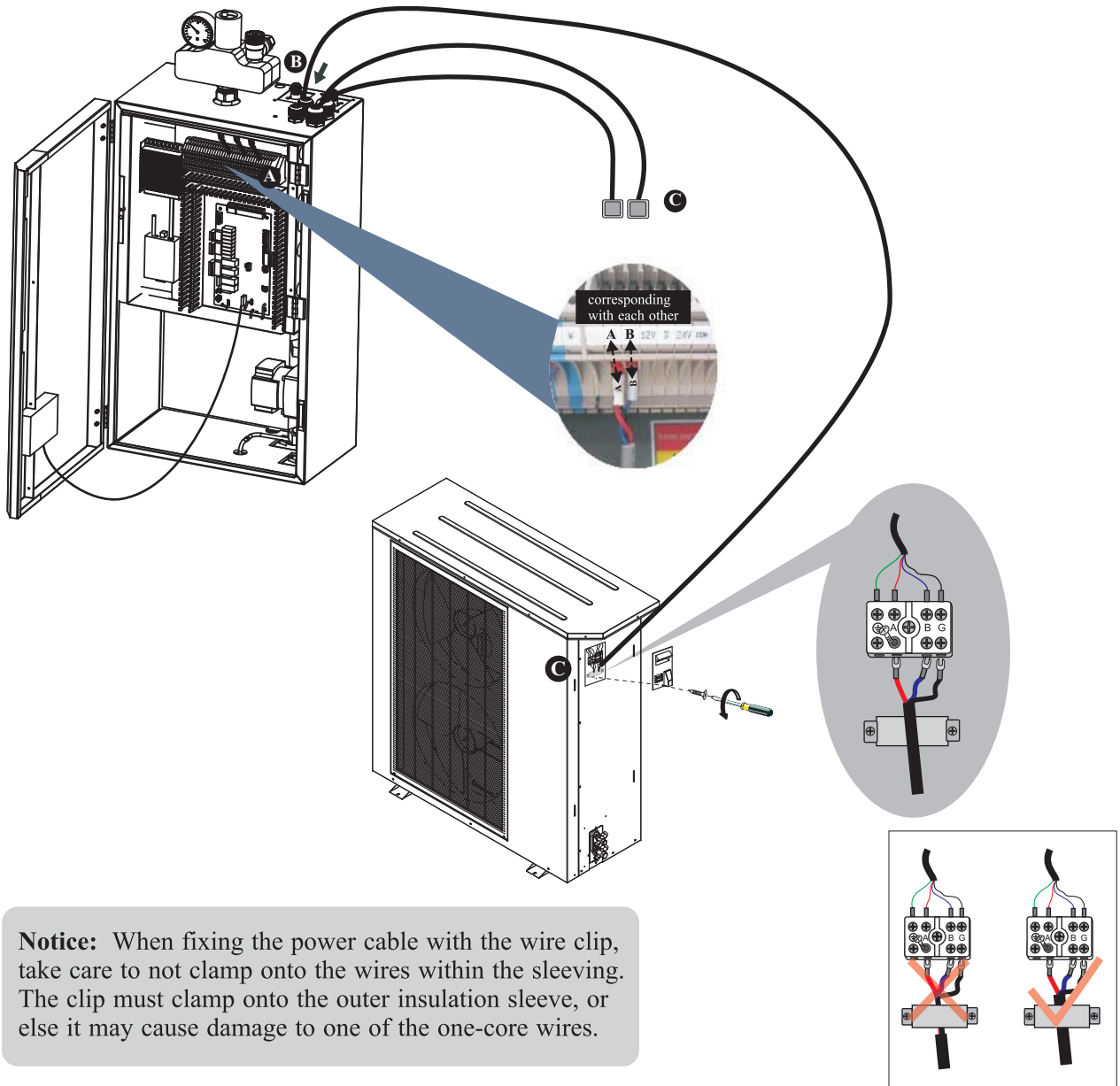

- A. Insert one end of this cable through the cable gland on the bottom of the indoor unit, and connect it to A and B on the appropriate terminal block.
- B. Fasten the cable gland to ensure the cable won't get loosen.
- C. Connect the other end of the cable to the terminal block on the outdoor unit. A and B on the indoor unit should be connected with A, B, and G on the outdoor unit, otherwise communication failure error may occur.

# 4. Installation Walkthrough

## 4.5. Wiring

5) Connect the power cable between the indoor and outdoor unit:

Acquire a 3-core power cable of sufficient length that is compliant to all local safety regulations.

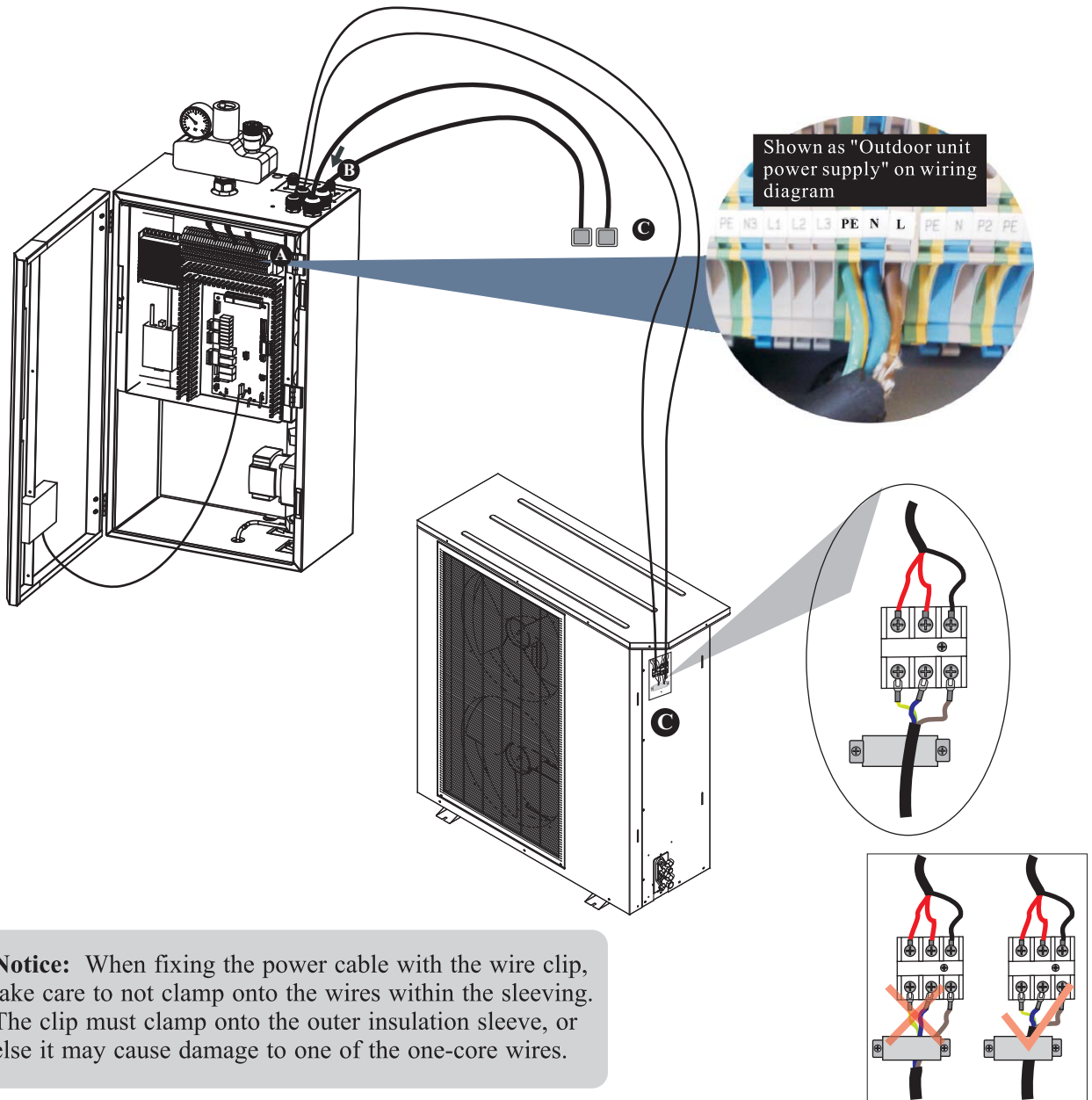

A. Insert one end of this cable through the cable gland on the bottom of the indoor unit, and connect it to A and B on the appropriate terminal block.

B. Fasten the cable gland to ensure the cable won't get loosen.

C. Connect the other end of the cable to the terminal block on the outdoor unit. A and B on the indoor unit should be connected with A, B, and G on the outdoor unit, otherwise communication failure error may occur.

## 4. Installation Walkthrough

### 4.5. Wiring

6) Connect the sensors and communication cables to the indoor unit.

- Retrieve all sensors and communication cables from the accessories bag.
- Connect all sensors to the communication cables, and insert the male end into the indoor unit through the cable glands.
- Connect them to the female quick connectors inside the indoor units.
- Place all sensors in the correct positions.
- After everything is connected, fasten the cable glands to prevent cables from loosening.

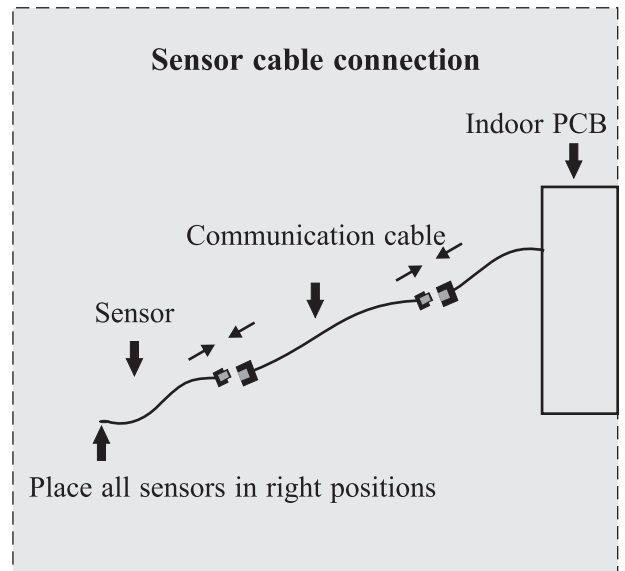

7) Re-install the electrical box cover, as well as the small handle on the back of the outdoor unit, and close the the indoor unit door.

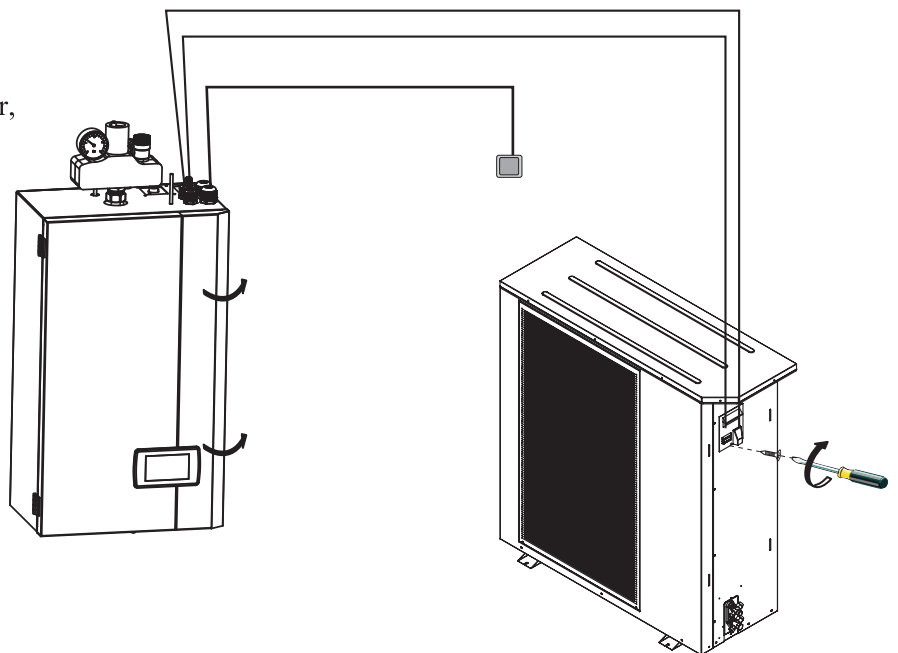

The wiring process is then complete.



# 4. Installation Walkthrough

## 4.6. Refrigerant Pipework

### 4.6.1. Amount of Refrigerant:

For all units, the refrigerant included inside is sufficient for up to 5 meter long piping kits. If the piping is beyond 5m, it is necessary to add 40g of refrigerant per additional meter. It is recommended to keep the length of the refrigerant piping to under 12m.

*Ex. If the pipe is 9m in length,  $4 \times 40g = 160g$  of refrigerant will need to be added.*

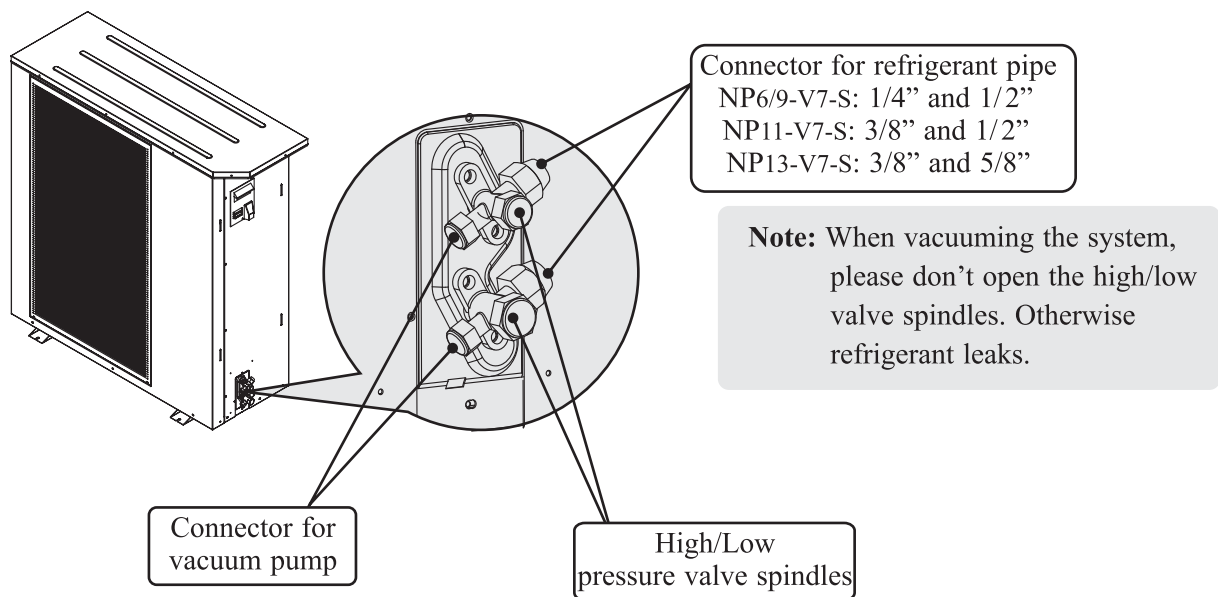

### 4.6.2. Precautions

Because the refrigerant pipe transfers heat to the entire system, any insufficient vacuuming and/or leakage of the refrigeration system will lead to decreased performance. Therefore, please ensure the following:

- Select a high quality refrigerant pipe that conforms to the pressure standards of Refrigerant R410A.
- Insulate the pipe before connecting it.
- Avoid bending/deforming the refrigerant pipe as much as possible.
- Ensure the inside of the pipe is completely dry, to avoid trapping moisture in the pipeline.
- Any walls or separators between the indoor and outdoor unit should have a wall sleeve fixed to the hole, which the installer should drill in order to accommodate the refrigerant pipe.
- Do not insulate the refrigerant pipes together. (Fig.1)  
Each pipe requires its own insulation. (Fig.2)

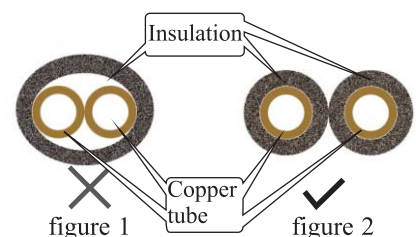

# 4. Installation Walkthrough

## 4.6. Refrigerant Pipework

### IMPORTANT:

The radius of pipe bends cannot be less than 15 cm.  
Use a cardboard/paper template to verify it is above this.  
Run the power cord through the pipe as it bends.  
Create the bends carefully and gradually.  
Do not bend the pipe against an edge.

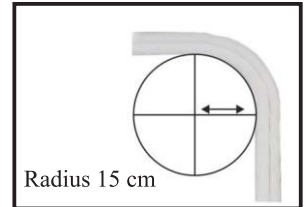

### 4.6.3. Installation:

Please connect the refrigerant pipe as follows:

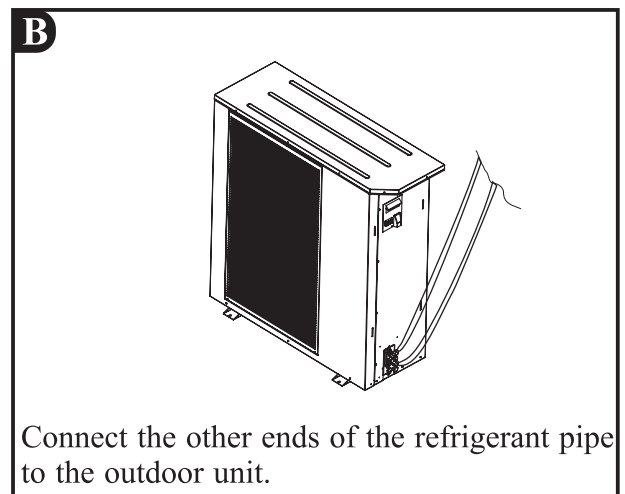
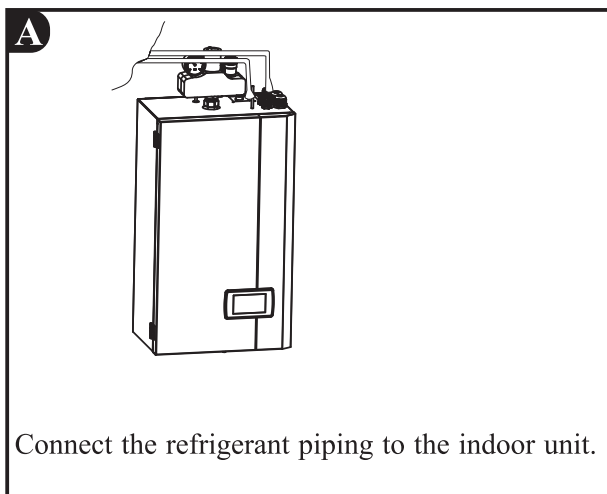
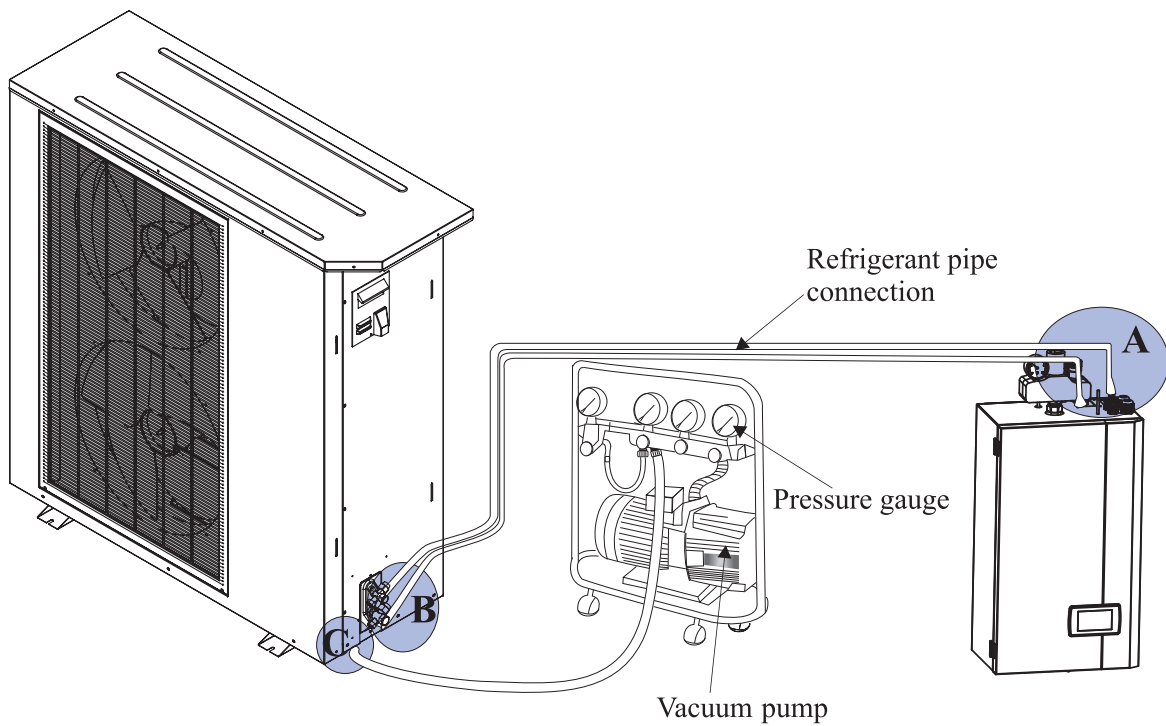

## 4. Installation Walkthrough

### 4.6. Refrigerant Pipework

**C**

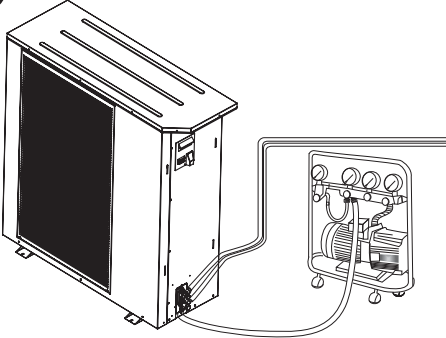

Prepare a vacuum pump and a pressure gauge, connect one end of the pressure gauge to the vacuum pump. The other end should be connected to high pressure refrigerant port on the outdoor unit.

---

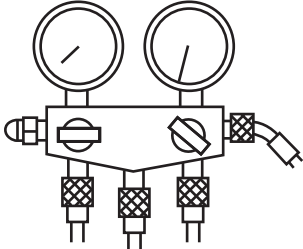

Open the pressure gauge, and set the vacuum pump to run for 10 minutes. Once the pressure gauge shows a negative pressure reading, turn off the vacuum pump and the gauge.

Disconnect the tube ends of pressure gauge, and install the copper nut back to the high pressure connection port.

---

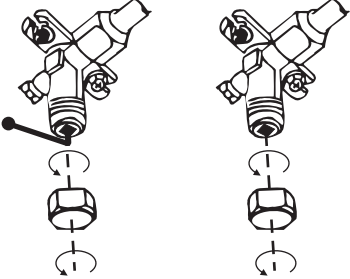

Remove the copper nut from the gas and liquid valves. open the valves all the way using a hexagon spanner.

---

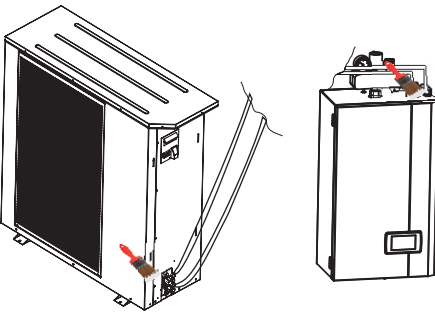

Check for any leakage using a detector, or soapy water. If no leakage is detected, retighten the copper nuts back onto the valves.

# 4. Installation Walkthrough

## 4.7. Water Pipework

After installation of the unit is complete, connect the water inlet to outlet pipe according to local regulations, and confirm that there is flow. Have the piping pressure tested and cleaned before use.

### 4.7.1. Filtration

A mesh filter should be installed between the water inlet of the unit and the water tank in order to keep collect any impurities and preserve water quality. The filter should be aimed down like below.

It is highly recommended to install check valves on both sides of the filter, to make cleaning or changing the filter later on easier.

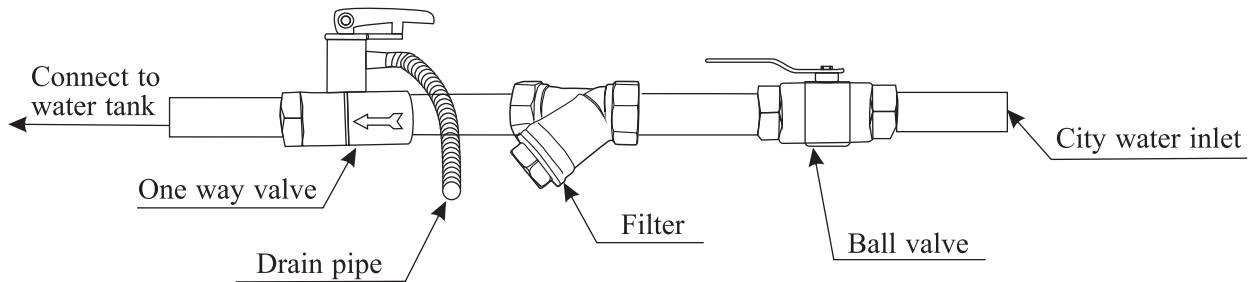

### 4.7.2. Insulation

All pipes running hot water should be well-insulated. No gaps should exist between insulation and outer pipe. Keep the check valves uncovered for future maintenance.



Before finishing, ensure that there is sufficient pressure to send water to the required heights. If not, a water pump can be added in order to increase pumping head.

### 4.7.3. Water Quality Standards

- Water should contain less than 300 ppm of chloride (in temperatures less than 60°C )
- The pH value of the water should be between 6 to 8.
- No water containing ammonia should pass through this unit.

If the water quality is bad or the water flow is too weak, scale formation and clogging may eventually occur, which lowers efficiency of cooling and heating and can cause abnormalities to occur.

Use pre-cleaned water, or purified water. Good water quality keeps the unit running in high efficiency.

# 4. Installation Walkthrough

---

## 4.8. Test run

---



After installation finished, please fulfill the water system with water and purge out air in the system before start-up.

### 4.8.1. Before start-up

The list of verifications below must be performed before the unit starts up, to ensure best possible conditions for smooth long-term operation. The list is not exhaustive, and should only be used on a minimum reference basis:

- 1) Make sure the fans are rotating freely.
- 2) Confirm correct flow directions in water piping.
- 3) Verify all system piping matches installation instructions.
- 4) Check the voltage of the unit power supply and make certain it complies to authorized limitations.
- 5) The unit must be properly grounded.
- 6) Check for the presence of any damaged devices
- 7) Check all electrical connections and ensure they are secure.
- 8) Make sure there are no leaks in the piping and the space is well-ventilated.

Fix any problems above if they occur. If everything above is satisfied, the unit can start up.

### 4.8.2. Starting Up

When the installation of the unit is completed, all water system pipes are confirmed to be well-connected, air purging is done, there are no leakages or other problems, the unit can be powered on.

Turn on the unit by pressing the on/off button on the operation panel. Listen carefully for any abnormal noise or vibrations, and ensure the display of the wired controller is normal.

After the unit has been on for 10 minutes and no abnormalities have occurred, the start-up process is complete. For problems and troubleshooting, please refer to the Service and Maintenance manual.

*Final note: It is suggested to not run "heating" or "hot water" mode during ambient temperatures above 32°C , otherwise the unit may easily enter protection mode.*

# Appendix A: Wiring

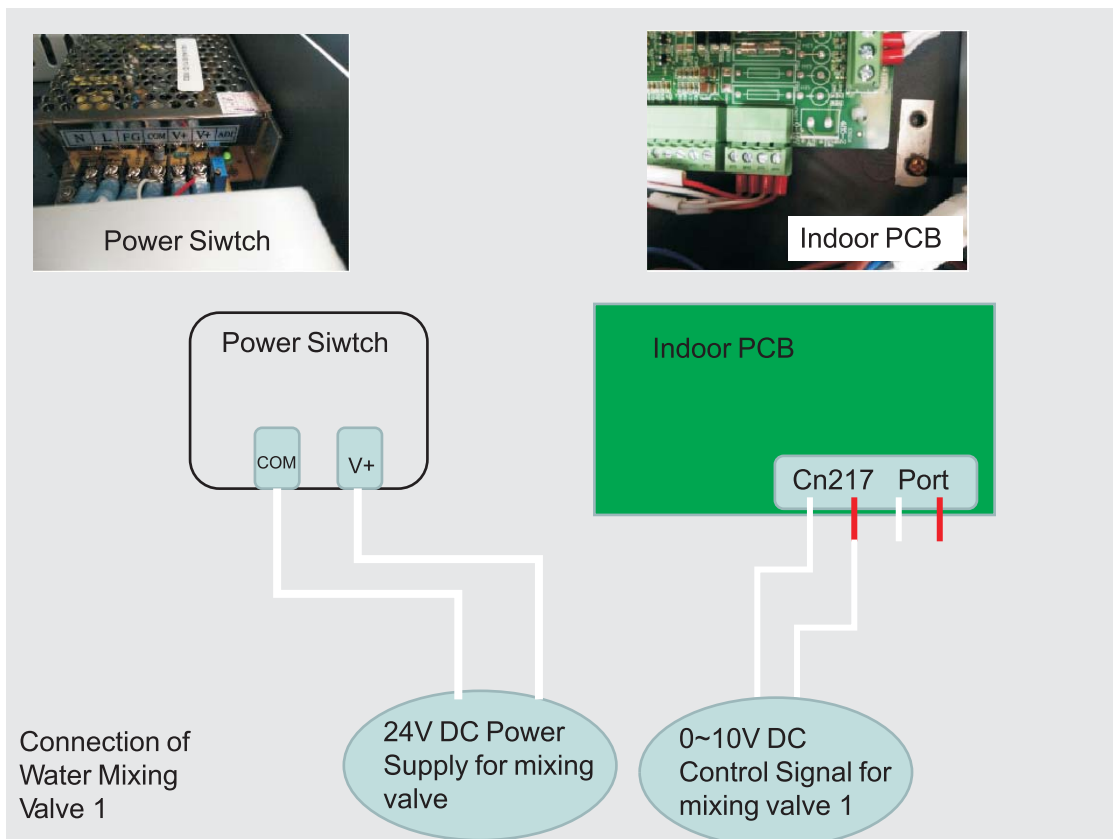
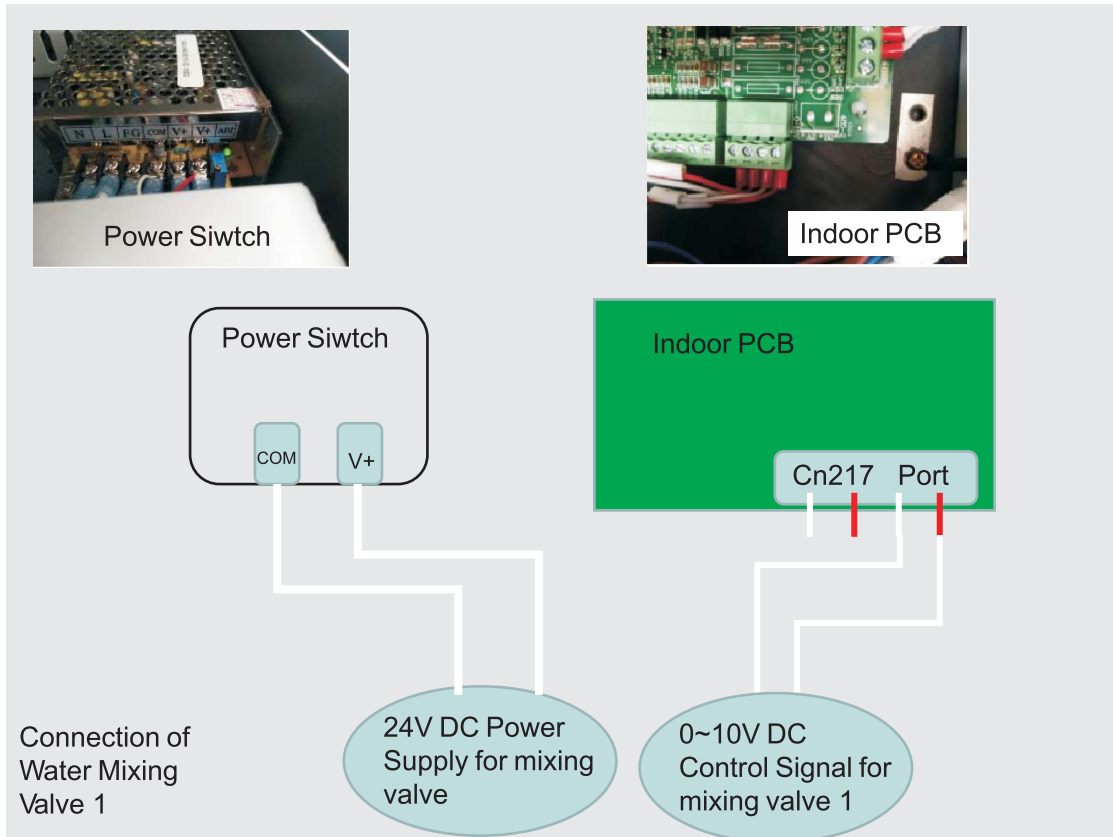

# Appendix A: Wiring

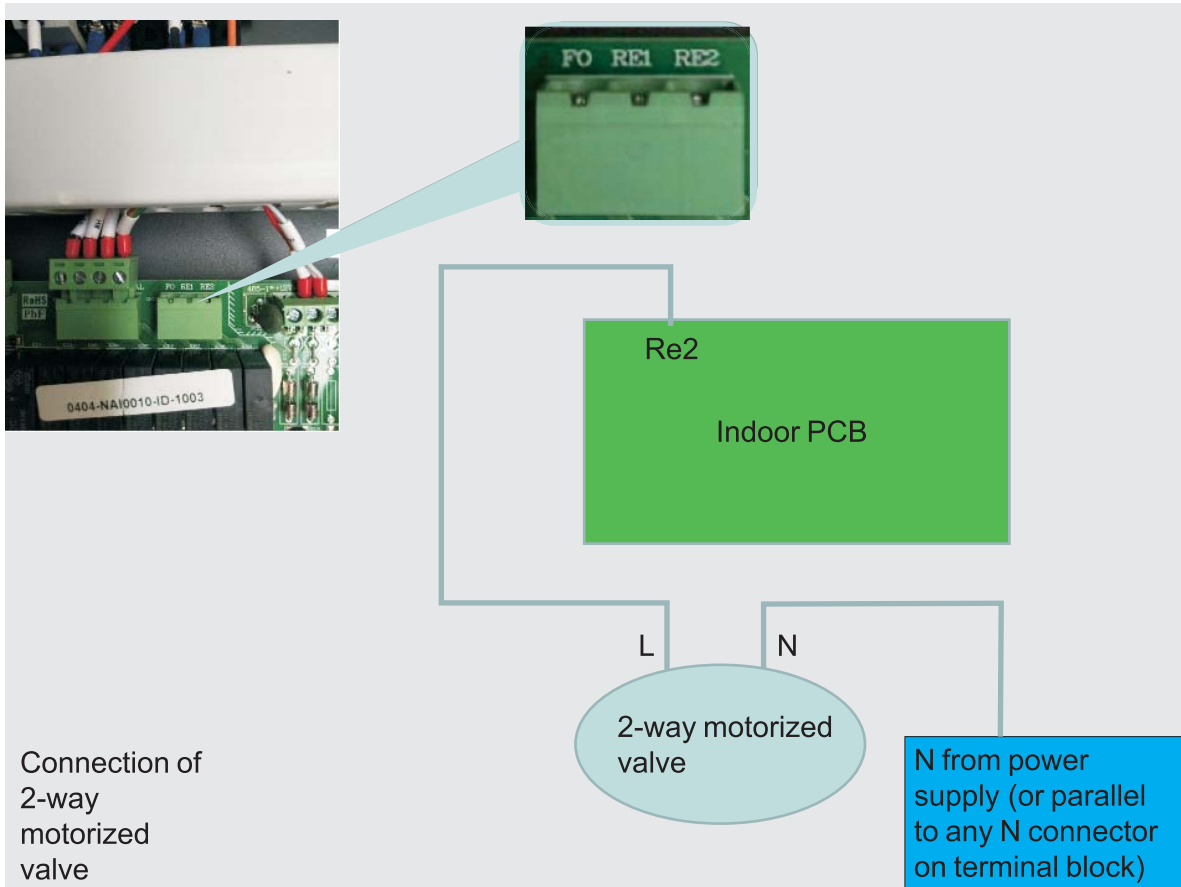





# Appendix B: Wiring

Outdoor — NP6-V7-S  
 NP9-V7-S  
 NP11-V7-S  
 NP13-V7-S

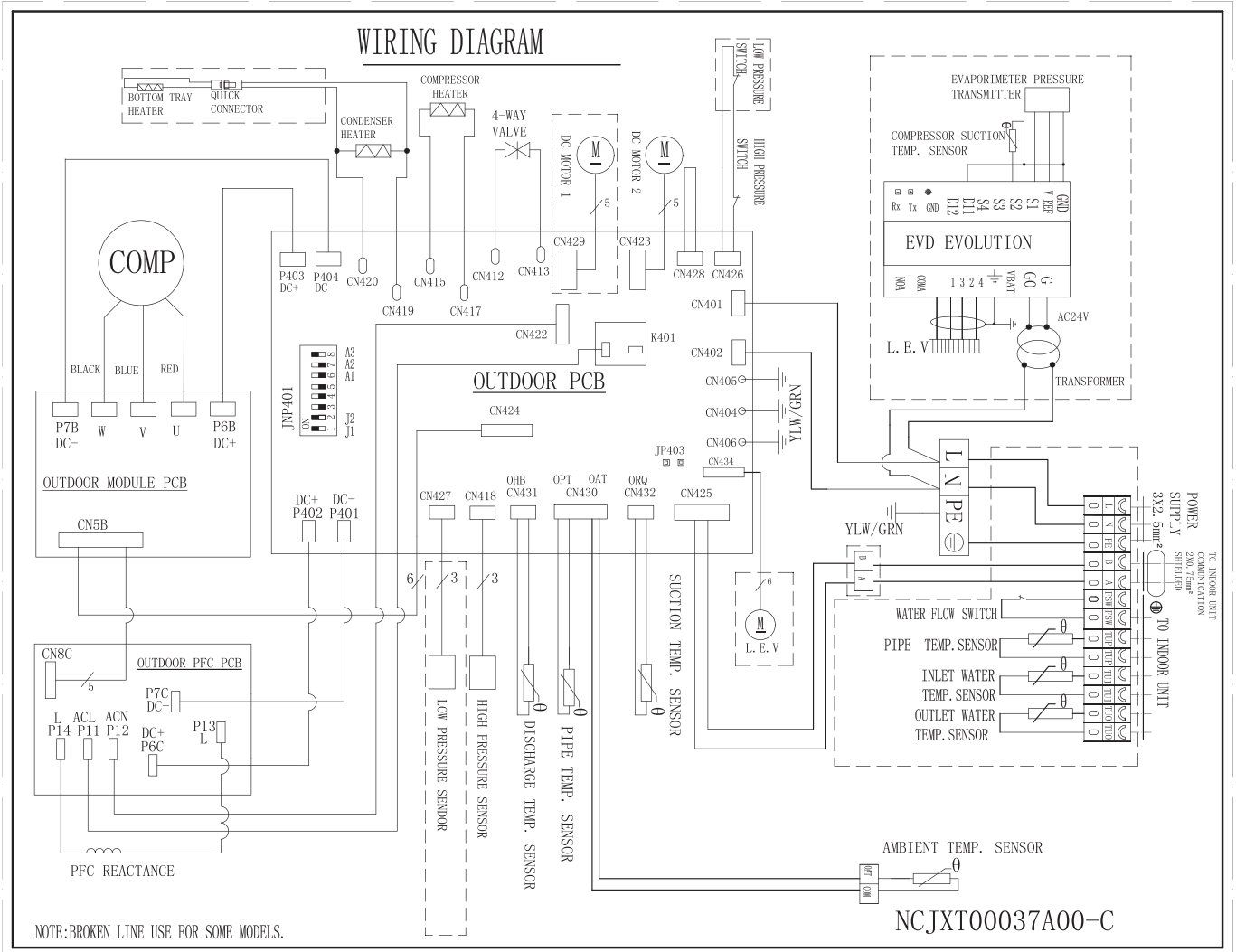

**TAKE CARE!**

The specifications are subject to change without prior notice.  
 For actual specifications of the unit, please refer to the specification stickers on the unit.







ES Heat Pumps AB, 44138 Alingsås, Sweden  
info@energysave.se  
www.energysave.se

Thank you for purchase of our quality product.  
Please read this manual thoroughly before use , and  
follow the instructions carefully in operating the unit  
in order to prevent damages to either the device or persons.

Product specifications are subject to change with improvements ,  
without prior notice. Please refer to the specification sticker on  
the unit for the most recent specifications.

Please refer to the contact information  
below for technical support and enquiries:

**E-mail:**

**Telephone:**